

LA  
MARCA  
QUE  
MEJOR  
TE SIENTA

**DVN**<sup>®</sup>  
S T A R  
La marca que mejor te sienta



La verdadera emoción es tener la certeza de que eres única y natural.

Por tu originalidad, por tu manera de ser...por tu ingenio, tu valentía y carácter aventurero...por tu color, tu alegría y saber vivir...por ser tú.

The real emotion is to be sure that you are unique and natural.

For your originality, your way of being, your ingenuity, your bravery, adventurous character, your color, joy and knowing how to live, for being you.

La véritable émotion est d'être certain que vous êtes unique et naturel.

Par ton génie, ton courage et aventureux caractère...par ta couleur, ta joie et savoir vivre... Pour être toi.



**OVN**<sup>®</sup>  
S T A R  
La marca que mejor te sienta

En Divani Star hemos cumplido 20 años en el mundo de la fabricación y venta de muebles tapizados y en este tiempo y no sin esfuerzo hemos logrado situarnos en una posición de liderazgo. Como muestra de ello, ofrecemos una amplia oferta de sillones, sofás, rincóneras, chaise longue y en general de mueble tapizado para el hogar. Durante este tiempo hemos realizado una apuesta decidida por el diseño, la innovación y el desarrollo de nuevas tendencias y estilos de decoración.

Nuestro objetivo es sin duda la satisfacción de nuestros clientes y para ello contamos con una amplia red comercial en todo el país que le orientarán a la hora de realizar su elección. Y para que dicha elección sea la acertada contamos en nuestras instalaciones con un amplio espacio "showroom" y personal experto en diseño y decoración para dar a conocer nuestras últimas novedades a nuestra red comercial.

We have been fighting for more than twenty years to achieve the Leadership position we occupy right now in the making and trading and upholstering furnitures. As a proof of what we say, we offer a very huge number of different types of armchairs, couches, corner-pieces, long chairs and in general upholstered furniture for the household. During the time we've been working, we've created a challenge influenced by design, innovation and the rise of new tendencies and styles of decoration.

Our main aim is of course the satisfaction and joy of our clients and because of that we work with a very wide commercial network in all over the country to advise clients at the moment they want to make a choice. As we are always worried about the clients' satisfaction, we have got a very big showroom in which is a staff of experts in design and decoration to show and explain our last innovations and creations to our commercial network.

Nous venons de célébrer notre 20<sup>e</sup> anniversaire dans la fabrication, revêtement et vente de meubles avec beaucoup de difficultés. Nous avons réussi à nous placer en une position de leader dans ce domaine. Comme preuve de notre leadership, nous disposons d'une grande variété de fauteuils, canapés, meubles d'angle, chaises longues et en général de meubles revêtus pour la maison. Durant tout ce temps de dur labeur, nous avons fait un pari décidé pour le design, l'innovation et le développement de nouvelles tendances et styles de décoration.

Notre objectif est sans aucun doute la satisfaction de notre clientèle, et pour cela nous sommes accompagnés d'un très grand réseau de commerciaux sur tout le territoire national pour ce qui est de l'orientation des clients au moment de faire leurs choix. Et pour que ce choix soit la bonne, nous disposons d'un "show room" qui est en d'autres termes un espace assez grand avec un personnel expert et compétent en design et décoration pour faire connaître nos nouveautés au réseau commercial.



# Índice / Index



Chocolate / pag. 10



Cayetana / pag. 22



Charlot / pag. 30



Bimba / pag. 38



Daytona / pag. 172



Enara / pag. 180



Silver / pag. 188



Vecchio / pag. 196



Tousi / pag. 48



Fendy / pag. 58



Toscana / pag.68



Dyor / pag. 76



Bon / pag. 204



Maxim / pag. 210



Big confort / pag. 218



Eiffel / pag. 228



Valenciaga/ pag. 84



Eden / pag. 94



Pradas / pag. 102



Ds / pag. 112



América / pag. 236



Laren / pag. 244



Luigi / pag. 246



Taycan / pag. 248



California / pag. 122



Room / pag. 130



Andrea / pag. 138



Sandy / pag. 146



Rosalía / pag. 250



Leonor / pag. 252



Pradas / pag. 254



Nube / pag. 256



Bed / pag. 156



Creta / pag. 162



**DVN**<sup>®</sup>  
S T A R  
La marca que mejor te sienta



**DVN**<sup>®</sup>  
S T A R  
La marca que mejor te sienta



Chocolate 3 pl. asientos y decorativos en Dolce 3007, resto tapizado en Vittta 3007  
Chocolate 3 seaters , seat cushions and decorative pillows upholstered in dolce 3007 , teh rest goes in vittta 3007  
Chocolat 3 places assises et decos revêtu de dolce 3007 , reste en vittta 3007

# Chocolate

Chocolate y decorativos en Chanel Coffee / Composition Chocolaté, tout en chanel coffee



# Chocolate

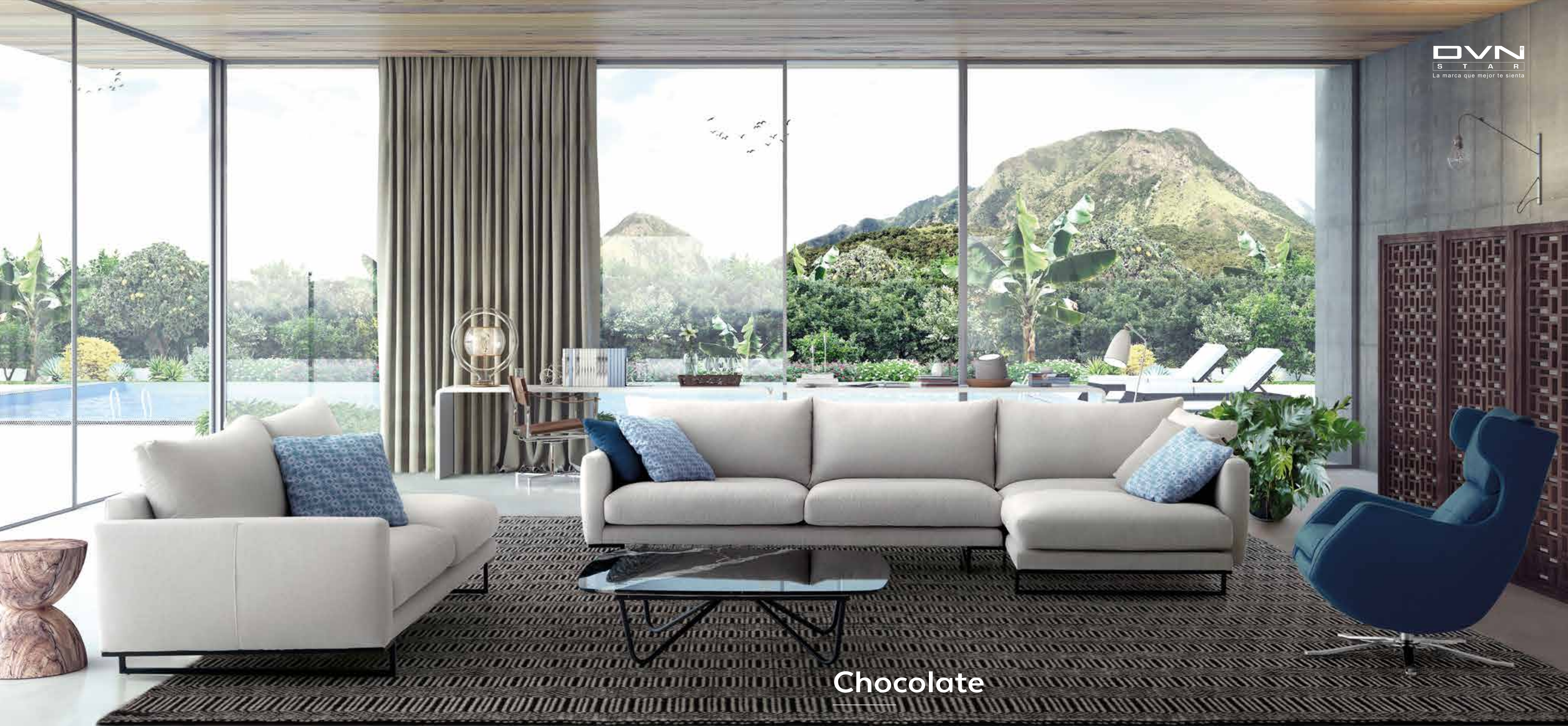

## Chocolate

Chocolate 3 pl. y chaiselongue en Amaral 56, butaca América en piel Módena Blue  
Chocolate 3 pl + chaiselong in amaral 56, America chair in Modena blue leather / Chocolate 3 pl + chaiselongue en Amaral 56, fauteuil America en cuir modena blue





Chocolate 3 pl. en Amaral 56, decorativos en Amaral 407  
Chocolate 3 pl in amaral 56, decorative cushion in amaral 407 / Chocolate 3 pls + chaiselongue en amaral 56, coussins deco en amaral 407



Chocolate 3 pl. + Chaiselongue en Amaral 60, decorativos en Amaral 60  
Chocolate three seaters plus chaiselong upholstered in amaral 60 .decorative pillows in 60  
Chocolate 3 places plus chaiselongue revêtu de amaral 60, coussins deco en amaral 60









Chocolate terminal en Amaral 347, decorativos en Amaral 347  
Chocolate terminal in amaral 347, decorative pillows in amaral 347  
Chocolate module terminal revêtu de amaral 347, coussins deco en amaral 347

# Chocolate

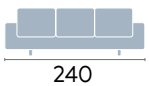
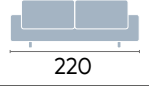
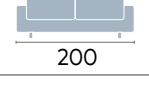
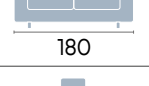
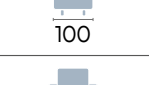
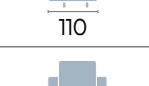
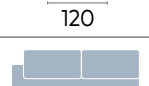
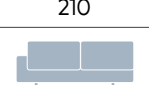
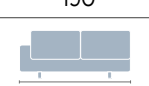

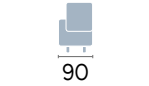
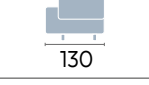
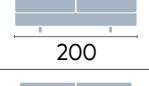
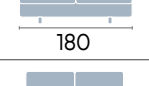
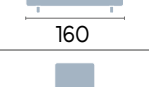
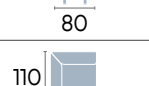
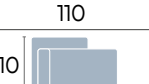
## Chocolate

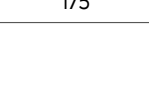
# Chocolate

Tarifa por puntos/rate/tarif	medidas / measurements / mesures			Series telas / Fabrics series / Série de tissus						Series piel / Leather series / Série cuir				Metroje	Nº Decorativos	Cubicaje M <sup>3</sup>
	Largo	Fondo	Altura	G/0	G/1	G/2	G/3	G/4	T Cliente	Piel 1	Piel 2	Piel 3	Piel 4			
 240 Chocolate 3 cabezas 2,40	240	100	85	533	571	621	658	697	506	1070	1120	1229	1349	15,2	2 hilton + 2 * 50 * 50	1,53
 220 Chocolate 3 pl a 2,20	220	100	85	446	479	520	551	584	424	975	1023	1126	1238	14,2	2 hilton + 2 * 50 * 50	1,4
 200 Chocolate 3 pl a 2,00	200	100	85	425	459	495	525	557	404	900	945	1039	1143	13,4	2 hilton + 2 * 50 * 50	1,28
 180 Chocolate 2 pl	180	100	85	405	439	479	508	538	385	800	840	924	1016	12,6	2 hilton + 2 * 50 * 50	1,15
 100 Chocolate 1 pl, cojín 80 cm	100	100	85	324	357	389	412	437	308	450	473	521	574	7	1 hilton + 1 * 50 * 50	0,64
 110 Chocolate 1 pl, cojín 90 cm	110	100	85	328	361	395	419	444	312	475	499	549	604	7,2	1 hilton + 1 * 50 * 50	0,71
 120 Chocolate 1 pl, cojín 100 cm	120	100	85	334	368	401	425	451	317	500	525	577	635	7,5	1 hilton + 1 * 50 * 50	0,77
 210 Chocolate mod. 3 pl 210 1/b	210	100	85	425	459	495	525	557	404	927	972	1070	1177	10,5	1 hilton + 1 * 50 * 50	1,34
 190 Chocolate mod. 3 pl 190 1/b	190	100	85	405	439	479	508	538	385	855	898	988	1086	9,6	1 hilton + 1 * 50 * 50	1,22
 170 Chocolate 2 pl 1/b	170	100	85	384	419	459	487	516	365	760	798	878	966	9,3	1 hilton + 1 * 50 * 50	1,09
 110 Chocolate mod. 1 pl 110 1/b	110	100	85	330	364	395	419	444	314	658	723	795	875	6,5	1 deco	0,71
 100 Chocolate mod. 1 pl 100 1/b	100	100	85	324	357	389	412	437	308	452	475	523	576	6,3	1 deco	0,64
 90 Chocolate mod. 1 pl 90 1/b	90	100	85	320	353	383	406	430	304	428	450	495	545	6	1 deco	0,58
 130 Chocolate mod. 1 pl 130 1/b	130	100	85	340	374	405	429	455	323	673	740	814	895	8,1	1 deco	0,83
 200 Chocolate mod 3 pl 200 s/b	200	100	85	405	439	479	508	538	385	881	924	1017	1119	10,2	-	1,28
 180 Chocolate mod 3 pl 180 s/b	180	100	85	384	419	455	482	511	365	813	854	939	1032	9,8	-	1,15
 160 Chocolate mod 2 pl s/b	160	100	85	365	398	435	461	489	347	722	759	835	918	8,3	-	1,02
 80 Chocolate mod 1 pl s/b	80	100	85	284	316	336	356	377	270	361	380	418	458	4,6	-	0,51
 110 Chocolate mod. rincón 1,10 * 1,10	110	110	85	365	398	435	461	489	347	600	650	700	800	6,25	-	0,77
 110 Chocolate chaiselóngue 110*175	110	175	85	405	436	479	508	538	385	800	840	924	1016	8,5	2 hilton + 150*50	1,23
 100 Chocolate chaiselóngue 100*175	100	175	85	400	430	470	498	528	380	775	820	900	990	8,3	2 hilton + 150*50	1,12

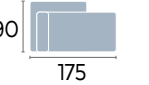
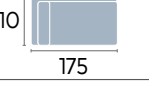
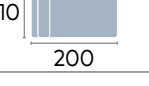
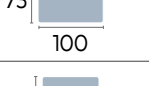
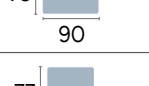
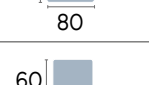
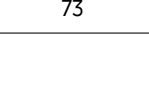
Tarifa por puntos/rate/tarif	medidas / measurements / mesures			Series telas / Fabrics series / Série de tissus						Series piel / Leather series / Série cuir				Metroje	Nº Decorativos	Cubicaje M <sup>3</sup>
	Largo	Fondo	Altura	G/0	G/1	G/2	G/3	G/4	T Cliente	Piel 1	Piel 2	Piel 3	Piel 4			
 90 Chocolate chaiselóngue 90*175	90	175	85	390	420	460	488	517	371	750	800	875	960	8	2 hilton + 150*50	1,01
 110 Chocolate chaiselóngue terminal 110*175	110	175	85	415	446	489	518	549	394	900	945	1039	1145	9,2	-	1,23
 110 Chocolate chaiselóngue terminal 110*200	110	200	85	446	479	520	551	584	424	975	1023	1126	1238	9,8	-	1,87
 73 Pouf 100 * 73	100	73	45	200	220	240	254	269	190	300	325	350	400	2,8	-	0
 73 Pouf 90 * 73	90	73	45	190	210	230	244	259	181	290	315	340	390	2,6	-	0
 73 Pouf 80 * 73	80	73	45	180	200	210	223	236	171	270	300	320	340	2,5	-	0
 60 Pouf 73 * 60	73	60	45	172	192	202	214	227	163	250	260	270	290	2,4	-	0



## Características técnicas / Technical characteristics / Caractéristiques techniques

- ESTRUCTURA: BASTIDOR METÁLICO CON MUELLES ZIG-ZAG
- ESTRUCTURA BRAZOS Y RESPALDOS: MADERA CON PARTÍCULAS
- ALMOHADAS ASIENTOS: GOMA 33 KG. + COJINES PICADO DE VISCOELASTICA Y FIBRA SILICONADA
- ALMOHADAS RESPALDO: FIBRA DE MICROFIBRA TACTO PLUMA
- PATAS: METÁLICAS TUBO CUADRADO. SE PUEDEN PONER PATAS DE AGUJA EN SOFAS (2 BRAZOS)
- DECORATIVOS: FIBRA SILICONADA Y PARTÍCULAS VISCOELÁSTICA
- ESTE MODELO, SIEMPRE QUE VAYA TAPIZADO EN PIEL, NO INCLUIRÁ DECORATIVOS DE SERIE EN NINGUNA DE SUS MODULACIONES
- STRUCTURE: CHASSIS METALLIQUE (AVEC RESSORTS NOZAG).
- ACCOUDOIRS ET DOSSIER: BOIS DE PARTICULE
- COUSSINS D'ASSISE: MOUSSE 33 KG, COUSSINS REMBOURRÉS DE VISCO HACHÉ ET FIBRE DE SILICONE.
- COUSSINS DE DOSSIER: FIBRE DE MICROFIBRE, TACT PLUMES.
- PIETEMENT: TUBE METALLIQUE CARRÉ (OPTION PIETEMENT POINTU UNIQUEMENT SUR LES CANAPÉS AVEC DEUX ACCOUDOIRS)
- LORSQUE CE MODELE SE FABRIQUE EN CUIR, LES DECOS NE SONT PAS INCLUS
- STRUCTURE: METALLIC FRAME PROVIDED WITH ZIGZAG SPRINGS.
- ARM AND BACKREST: WOOD PARTICLES.
- SEAT CUSHION: FOAM 33 KG. , CUSHIONS FILLED WITH CHOPPED VISCO AND SILICONE FIBER
- BACK CUSHION: FIBER OF MICROFIBER, FEATHER TOUCH.
- LEGS: SQUARE METALLIC TUBE (OPTION: POINTED FEET ONLY ON SOFAS WITH TWO ARMRESTS).
- WHEN THIS MODEL IS MADE IN LEATHER, THERE IS NO DECORATIVE PILLOW INCLUDED

## Opciones de patas / Leg options / Options de jambe



## Bastidor metálico

/ Metallic frame / Chassis metallique

El cambio de pata puede suponer un incremento en el precio. / Le changement de piètement peut entrainer un supplément sur le prix. / Change of legs could lead to a supplement.

En las 15 y 28 solo se pueden incorporar en el sofá con 2 brazos. /

Number 15 and 28 only can be used in sofa provided with two handrests. / Le numero 15 et 28 peuvent uniquement être utilisés sur le canapé avec deux accoudoirs.



# Cayetana

Cayetana terminal en Boston cement, decorativos en Boston pink y Jungle granate  
Cayetana, 3 seaters plus terminal chaiselong upholstered in Boston cement, decorative pillows in Boston Pink and jungle deep red  
Cayetana 3 places plus chaiselong terminale revêtu de Boston cement, coussins deco en Boston Pink et jungle rouge obscur

Cayetana pág. izquierda en Boston turquoise, decorativos en Boston mouse y Jungle azul  
Cayetana in Boston turquoise, pillows in Boston Mouse and Jungle blue / Cayetana en tissu Boston turquoise, coussins deco en Boston Mouse et Jungle bleu.



## Cayetana

Cayetana es un modelo de gran poder visual, de una contundencia y compacidad formal arrebataadora. La ponencia expresiva de su diseño nos deja sin palabras.

Cayetana is a model of a great visual power, a strong and formal compactness. The expressive presentation of its design leaves one speechless.

Cayetana est un modèle attractif avec résistance extraordinaire. L'imposition expressive de son design nous laisse sans mots.

Cayetana terminal en Boston sky, decorativos en Boston black y Jungle azul  
Cayetana terminal chaiselong in boston sky, pillows in boston black and jungle blue / Cayetana , chaiselongue terminale en bostob sky, coussins deco en boston black et jungle bleu  
Cayetana pág. derecho en Boston pink, decorativos en Boston mouse y Jungle granate  
Cayetana terminal chaiselong in boston pink, pillows in boston mouse and jungle granate / Cayetana, chaiselongue terminale en bostob pink, coussins deco en boston mouse et jungle granate





# Cayetana

# Cayetana

Tarifa por puntos/rate/tarif	medidas / measurements / mesures			Series telas / Fabrics series / Série de tissus						Series piel / Leather series / Série cuir				Metroaje	Nº Decorativos	Cubicaje M <sup>3</sup>
	Largo	Fondo	Altura	G/0	G/1	G/2	G/3	G/4	T Cliente	Piel 1	Piel 2	Piel 3	Piel 4			
240	240	100	85	533	571	621	658	698	506	1070	1120	1229	1349	13,2	2 hilton + 2 riñoneras	1,53
220	220	100	85	497	534	579	614	651	472	995	1043	1146	1258	12,6	2 hilton + 2 riñoneras	1,40
200	200	100	85	473	512	552	585	620	449	920	965	1059	1163	12	2 hilton + 2 riñoneras	1,28
180	180	100	85	452	489	534	566	600	429	820	860	944	1036	11,6	2 hilton + 2 riñoneras	1,15
100	100	100	85	361	399	433	459	487	343	470	493	541	594	9	1 riñonera + 1 cab. flotante	0,64
110	110	100	85	365	403	440	466	494	347	495	519	569	624	9,25	1 riñonera + 1 cab. flotante	0,71
120	120	100	85	373	410	448	475	503	354	520	545	597	655	9,5	1 riñonera + 1 cab. flotante	0,77
210	210	100	85	473	512	552	585	620	449	947	992	1090	1197	12	1 hilton + 2 riñoneras	1,34
190	190	100	85	452	489	534	566	600	429	875	918	1008	1106	11,5	1 hilton + 2 riñoneras	1,22
170	170	100	85	428	467	512	543	575	407	780	818	898	986	11	1 hilton + 2 riñoneras	1,09
110	110	100	85	369	406	440	466	494	351	678	743	815	895	8,5	1 hilton + 1 riñonera	0,71
100	100	100	85	361	399	434	460	488	343	472	495	543	596	8,2	1 hilton + 1 riñonera	0,64
90	90	100	85	357	394	427	453	480	339	448	470	515	565	7	1 hilton + 1 riñonera	0,58
130	130	100	85	379	417	452	479	508	360	693	760	834	915	8	1 hilton + 1 riñonera	0,83
200	200	100	85	452	489	534	566	600	429	901	944	1037	1139	10	2 riñoneras	1,28
180	180	100	85	428	467	508	538	571	407	833	874	959	1052	9,5	2 riñoneras	1,15
160	160	100	85	407	443	485	514	545	387	742	779	855	938	9	2 riñoneras	1,02
80	80	100	85	317	353	375	398	421	301	381	400	438	478	6	1 riñonera	0,51
110	110	110	85	407	443	485	514	545	387	620	670	720	820	6,5	-	0,77
110	110	175	85	446	480	524	555	589	424	820	860	944	1036	10	2 hilton + 1 riñonera	1,23
100	100	175	85	435	468	513	544	576	413	795	840	920	1010	10	2 hilton + 1 riñonera	1,12

Tarifa por puntos/rate/tarif	medidas / measurements / mesures			Series telas / Fabrics series / Série de tissus						Series piel / Leather series / Série cuir				Metroaje	Nº Decorativos	Cubicaje M <sup>3</sup>
	Largo	Fondo	Altura	G/0	G/1	G/2	G/3	G/4	T Cliente	Piel 1	Piel 2	Piel 3	Piel 4			
90	90	175	85	463	497	545	578	612	440	770	820	895	980	10	2 hilton + 1 riñonera	1,01
100	100	200	85	452	486	534	566	600	429	920	965	1059	1165	11,6	1 hilton + 1 riñonera	1,28
73	100	73	44	222	245	267	283	300	211	320	345	370	420	2,8	-	0,30
73	90	73	44	211	234	256	271	288	200	310	335	360	410	2,8	-	0,30
73	80	73	44	201	222	234	248	263	191	290	320	340	360	2,75	-	0,20
60	73	60	44	191	214	225	239	253	181	270	280	290	310	2,5	-	0,20



## Características técnicas / Technical characteristics / Caractéristiques techniques

- ESTRUCTURA: BASTIDOR METÁLICO (CON MUELLES ZIG-ZAG)
- ESTRUCTURA BRAZOS Y RESPALDOS: MADERA CON PARTICULAS
- ALMOHADAS ASIENTOS: BULFLEX
- ALMOHADAS RESPALDO: MICROFIBRA (TACTO PLUMAS)
- PATAS DE SERIE: METÁLICAS
- ESTE MODELO, SIEMPRE QUE VAYA TAPIZADO EN PIEL, NO INCLUIRÁ DECORATIVOS DE SERIE EN NINGUNA DE SUS MODULACIONES
- STRUCTURE: CHASSIS METALLIQUE POURVU DE RESSORTS NOZAG.
- STRUCTURE ACCOUDOIRS ET DOSSIER BOIS DE PARTICULES.
- COUSSINS D'ASSISE: BULFLEX
- COUSSINS DE DOSSIER: MICROFIBRE (TACT PLUMES).
- COUSSINS DECO: FIBRE SILLICONNÉ Y PARTICULES DE VISCOLASTIQUE.
- PIETEMENT PAR DEFAULT: METALLIQUE.
- THERE IS NO DECORATIVE INCLUDED IN THIS MODELE WHEN IT IS MADE IN LEATHER
- STRUCTURE: METAL FRAME PROVIDED WITH ZIGZIG SPRINGS.
- STRUCTURE ARM AND BACKREST PARTICLES WOOD.
- SEAT CUSHION: BULFLEX
- BACK CUSHION: MICROFIBER (FEATHER TOUCH).
- DECORATIVE CUSHION: SILICONE FIBER AND VISCOLASTIC PARTICLES.
- DEFAULT LEGS: METAL.
- CE MODELE N'INCLUT PAS DE DECOS LORSQUE QU'IL EST FABRIQUÉ EN CUIR

## Opciones de patas / Leg options / Options de jambe

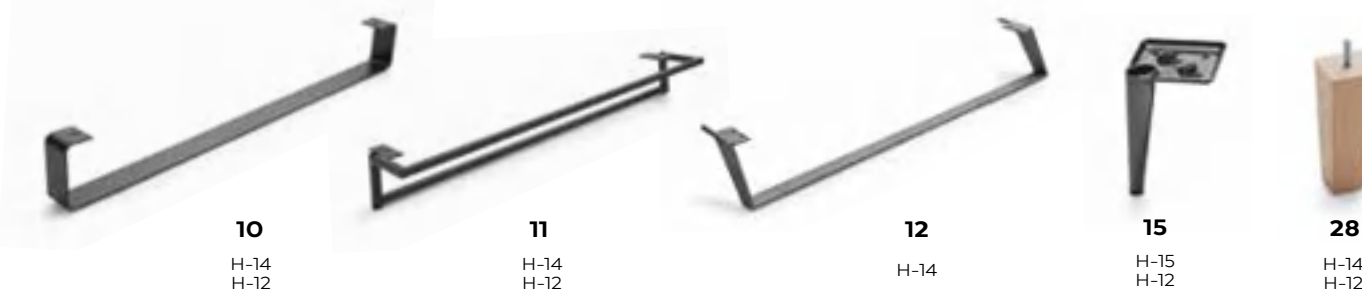

## Bastidor metálico

/ Metallic frame / Chassis metallique



El cambio de pata puede suponer un incremento en el precio. / Le changement de piètement peut entrainer un supplément sur le prix. / Change of legs could lead to a supplement.



# Charlot

Charlot 3 pl. en Evice 04 y piel Módena Tortora  
Charlot 3 seaters seat cushions, back cushions and inner part of armrest upholstered in Evice 04, frame in leather modena tortora.  
Charlot 3 places , coussins de dossier , assise et partie interne des accoudoirs en Evice 04 , structure en Cuir modena Tortora.  
Charlot pág. izquierda en Evice 01 y piel Módena Foresta  
Charlot page gauche , coussins d'assise et de dossier en Evice 01 , structure en Cuir modena forest.  
Charlot left page , seat and back cushions in Evice , framework in Modena forest leather.





## Charlot

Charlot 3 pl. + terminal en Boston pink, decorativos en Boston mouse y Jungle granate  
Charlot 3 seaters + terminal chaiselong i boston pink , decorative pillows in boston mouse and deep-red jungle  
Charlot 3 places + chaiselongue terminale en boston pink , coussins deco en boston mouse et jungle rouge bordeaux

Charlot nace de la búsqueda de una solución ideal que nos integre en un mismo sofá y como primer ingrediente, un diseño espectacular y vanguardista, idealizado, estilizando su aspecto hasta convertirlo en aerodinamismo puro, con una visión panorámica especialmente destacable en su vista frontal.

Charlot was born as an ideal solution to integrate in the same couch as first ingredient, a spectacular and innovator design, idealized, stylizing its appearance to become a pure aerodynamics, with a panoramic view specially in its front view.









Charlot est né de la recherche d'une solution idéale qui nous intègre dans le canapé et comme premier ingrédient un design spectaculaire et d'avant-garde, idéalisé en stylisant son aspect jusqu'à le changer en aérodynamisme pur, avec une vision panoramique spécialement détectable dans sa vue frontale.

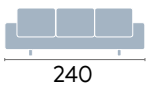
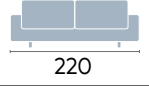
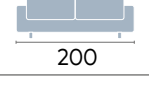
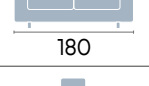
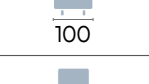
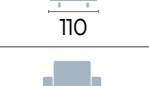
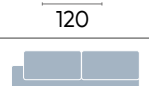
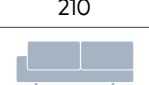
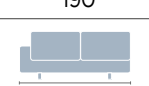

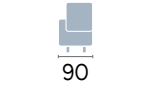

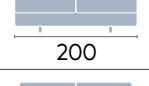
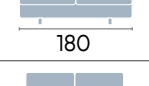
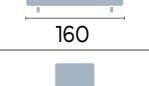
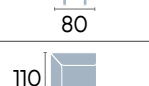
## Charlot

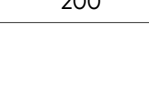
Charlot 3 pl. en piel Módena Terracota y Evice 01, butaca América en piel Módena Terracota  
Charlot 3 seaters with back, seat and inner part of armrest and cushions in Evice 01, rest in leather modena terracota, America chair in leather modena terracota  
Charlo 3 places, coussins d'assis, de dossier et partie interne des accoudoirs en Evice 01, le reste en Cuir modena terracota, fauteuil America entièrement revêtu de Cuir Modena terracota.

# Charlot

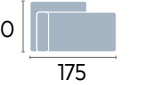
Tarifa por puntos/rate/tarif	medidas / measurements / mesures			Series telas / Fabrics series / Série de tissus						Series piel / Leather series / Série cuir				Metroje	Nº Decorativos	Cubicaje M <sup>3</sup>	
	Largo	Fondo	Altura	G/0	G/1	G/2	G/3	G/4	T Cliente	Piel 1	Piel 2	Piel 3	Piel 4				
85 	Charlot 3 cabezales 2,40	240	100	85	533	571	621	658	697	506	1070	1120	1229	1349	13,2	2 Hilton + 3 riñoneras	1,53
	Charlot 3 pl a 2,20	220	100	85	497	534	579	614	651	472	995	1043	1146	1258	12,6	2 Hilton + 2 riñoneras	1,4
	Charlot 3 pl a 2,00	200	100	85	473	512	552	585	620	449	920	965	1059	1163	12	2 Hilton + 2 riñoneras	1,28
	Charlot 2 pl	180	100	85	452	489	534	566	600	429	820	860	944	1036	11	2 Hilton + 2 riñoneras	1,15
	Charlot 1 pl (cojin asiento 0,80) 1,00	100	100	85	361	399	433	459	487	343	470	493	541	594	9	1 Hilton + 1 riñonera	0,64
	Charlot 1 pl (cojin asiento 0,90) 1,10	110	100	85	365	403	440	466	494	347	495	519	569	624	9	1 Hilton + 1 riñonera	0,71
	Charlot 1 pl (cojin asiento 1,00) 1,20	120	100	85	373	410	448	475	504	354	520	545	597	655	9,25	1 Hilton + 1 riñonera	0,77
	Charlot mod 3 pl a 2,10 1/br	210	100	85	473	512	552	585	620	449	947	992	1090	1197	12	1 Hilton + 2 riñoneras	1,34
	Charlot mod 3 pl a 1,90 1/br	190	100	85	452	489	534	566	600	429	875	918	1008	1106	10,7	1 Hilton + 2 riñoneras	1,22
	Charlot mod 2 pl 1/br	170	100	85	428	467	512	543	576	407	780	818	898	986	9,8	1 Hilton + 2 riñoneras	1,09
	Charlot mod 1 pl a 1,10 1/br	110	100	85	369	406	440	466	494	351	678	743	815	895	8,5	1 Hilton + 1 riñonera	0,71
	Charlot mod 1 pl a 1,00 1/br	100	100	85	361	399	434	460	488	343	472	495	543	596	8,5	1 Hilton + 1 riñonera	0,64
	Charlot mod 1 pl a 0,90 1/br	90	100	85	357	394	427	453	480	339	448	470	515	565	7	1 Hilton + 1 riñonera	0,58
	Charlot mod 1 pl a 1,30 1/br	130	100	85	379	417	452	479	508	360	693	760	834	915	9	1 Hilton + 1 riñonera	0,83
	Charlot mod 3 pl 2,00 s/br	200	100	85	452	489	534	566	600	429	901	944	1037	1139	10	2 Riñoneras	1,28
	Charlot mod 3 pl 1,80 s/br	180	100	85	428	467	508	538	570	407	833	874	959	1052	9,5	2 Riñoneras	1,15
	Charlot mod 2 pl s/br	160	100	85	407	443	485	514	545	387	742	779	855	938	9	2 Riñoneras	1,02
	Charlot mod 1 pl a 0,80 s/br	80	100	85	317	353	375	398	422	301	381	400	438	478	5	1 Riñonera	0,51
	Charlot mod rincón	110	110	85	407	443	485	514	545	387	620	670	720	820	6,5	1 Hilton	0,77
	Charlot chaiselón terminal	100	200	85	452	486	534	566	600	429	920	965	1059	1165	11,6	1 Hilton + 1 riñonera	1,28
	Charlot chaiselón 1,10 x 200	110	200	85	446	480	524	555	588	424	820	860	944	1036	10	2 Hilton + 1 riñonera	1,4

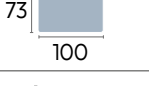
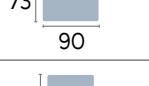
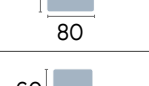
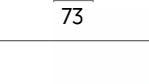
Tarifa por puntos/rate/tarif	medidas / measurements / mesures			Series telas / Fabrics series / Série de tissus						Series piel / Leather series / Série cuir				Metroje	Nº Decorativos	Cubicaje M <sup>3</sup>	
	Largo	Fondo	Altura	G/0	G/1	G/2	G/3	G/4	T Cliente	Piel 1	Piel 2	Piel 3	Piel 4				
100 	Charlot chaiselón 1,00 x 1,75	100	175	85	435	468	513	544	577	413	795	840	920	1010	10	2 Hilton + 1 riñonera	1,12
90 	Charlot chaiselón 0,90 x 1,75	90	175	85	463	497	545	578	613	440	770	820	895	980	10	2 Hilton + 1 riñonera	1,01
73 	Pouff 1,00 x 0,73	100	73		222	245	267	283	300	211	310	345	370	420	3	-	0,3
73 	Charlot pouff 0,90 x 0,73	90	73		211	234	256	271	287	200	310	335	360	410	3	-	0,3
73 	Charlot pouff 0,80 x 0,73	80	73		201	222	234	248	263	191	290	320	340	360	3	-	0,2
60 	Charlot pouff 0,73 x 0,60	73	60		191	214	225	239	253	181	270	280	290	310	3	-	0,2



## Características técnicas / Technical characteristics / Caractéristiques techniques

- ESTRUCTURA: BASTIDOR METÁLICO (CON MUELLES ZIG-ZAG)
- ESTRUCTURA BRAZOS Y RESPALDOS: MADERA CON PARTICULAS
- ALMOHADAS ASIENTOS: ALMOHADAS ASIENTOS EN BULFLEX\*
- ALMOHADAS RESPALDO: MICROFIBRA (TACTO PLUMAS)
- PATAS DE SERIE: METÁLICAS TUBO CUADRADO
- ESTE MODELO, SIEMPRE QUE VAYA TAPIZADO EN PIEL, NO INCLUIRÁ DECORATIVOS DE SERIE EN NINGUNA DE SUS MODULACIONES

\*BULFLEX es la espumación téctica celular mas avanzada del mercado gracias a su tecnología. Está compuesta de pequeñas celulas elásticas independientes que aportan una resistencia excepcional para su equilibrio perfecto en el apoyo. Su adaptabilidad, resistencia y transpirabilidad la convierten en una sentada más exigente.

- STRUCTURE : METALLIC FRAME WITH ZIGZAG SPRINGS
- STRUCTURE ARMREST AND BACKREST : WOOD PARTICLES
- SEAT CUSHION : FILLED IN BULFLEX FOAM
- BACK CUSHION : MICROFIBER GEATHER SENSATION
- LEGS : METAL
- THERE IS NO DECORATIVE PILLOW INCLUDED IN THIS MODEL WHEN IT IS MADE IN LEATHER

\*BULFLEX is one of the most advanced foam thanks to its technology . BULFLEX is made of small independant elastic cells that provide an exceptional resistance for a perfect balance . Its adaptability , resistance and breathability convert Bulflex into the best seat padding

- STRUCTURE : CHÂSSIS MÉTALLIQUE AVEC RESSORTS EN ZIGZAG
- STRUCTURE ACCOUDOIRS ET DOSSIER : BOIS DE PARTICULES
- COUSSIN D'ASSISE : REMBOURRÉE EN MOUSSE BULFLEX
- COUSSIN DE DOSSIER : MICROFIBRE SENSATION PLUME
- PIETEMENT : MÉTALLIQUE
- CE MODELE N'INCLUT PAS DE DECO LORSQU'IL EST FABRIQUÉ EN CUIR

\*BULFLEX est l'un des types de mousse les plus avancées grace à la technologie de sa fabrication. BULFLEX est composé de petites cellules élastiques indépendantes , ce qui lui procure une resistance exceptionnelle pour un parfait equilibre a l'appui . Son adaptabilité , sa resistance et sa respirabilité font de Bulflex, un materiel de rembourrage d'assise sans égal

## Opciones de patas / Leg options / Options de jambe



El cambio de pata puede suponer un incremento en el precio. / Le changement de piètement peut entrainer un supplément sur le prix. / Change of legs could lead to a supplement.

Charlot 3 pl. izquierda en cuir Modena Granato y Evice 02 / Charlot 3 pl. derecha en piel Modena Antracite y Evice 14 / Charlot 3 places gauche en cuir Modena rouge bordeaux et tissu Evice 02 / Charlot 3 places droit en cuir Modena Antracite et Evice 14 / Charlot 3 seaters left in modena leather deep-red and Evice 02 / Charlot 3 seaters right in Modena leather Antracite and Evice 14



# Bimba

Bimba 3 pl. + chaiselongue en Melody 17  
Bimba 3 seaters + chaiselong in Melody 17 / Bimba 3 places + chaiselongue en melody 17  
Bimba pág. izquierda en Melody 1  
Bimba, opposit page in melody 01 / Bimba page gauche en melody 01



Bimba 3 pl. + chaiselongue + pouf en Melody1, decorativos en Melody 1, Butaca América en piel Módena Nero  
Bimba 3 seaters + terminal chaiselong + pouf in melody 01, America chair in leather Modena Nero / Bimba + place + chaiselongue + pouf en melody 01, fauteuil America en cuir modena nero

**Bimba**



## Bimba

Podremos encontrar toda una familia de alternativas que se llegan a complementar a la perfección. La gran cantidad de opciones compositivas nos aseguran una solución ideal para cada caso.









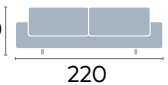
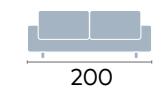
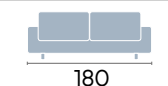

We can get several alternatives, and also complementary together. Big quantity of composition options that give us an ideal solution for every case.

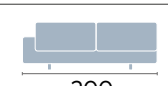
Nous pouvons trouver un grand nombre d'alternatives qui se complètent à la perfection. L'egrand nombre de différents composants nous assure une solution idéale pour chaque cas.

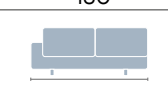
Bimba 3 pl. + chaiselongue en Melody 15, Melody 17 y Melody 13  
Bimba 3 seaters +chaiselong in melody 15, melody 17 and melody 13 / Bimba 3 places + chaiselongue en melody 15 , melody 17 et melody 13

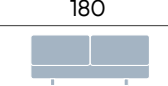
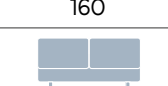
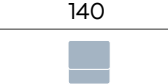
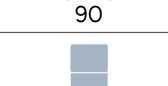
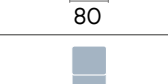
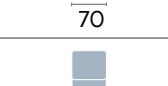
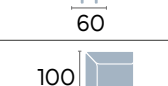
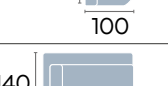
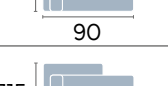

# Bimba

Tarifa por puntos/rate/tarif	medidas / measurements / mesures	Series telas / Fabrics series / Série de tissus					T Cliente	Metraje	Nº Decorativos	Cubicaje M <sup>3</sup>			
		Largo	Fondo	Altura	G/0	G/1					G/2	G/3	G/4
90 	Bimba 3 pl 2,20	220	90	90	450	477	501	531	563	400	11	2 DECO 50*50	1,60
	Bimba 3 pl a 2,00	200	90	90	430	456	479	508	538	390	10,5	2 DECO 50*50	1,46
	Bimba 2 pl	180	90	90	400	424	446	473	501	370	8,3	2 DECO 50*50	1,31
	Bimba 1pl	100	90	90	300	318	334	354	375	260	6,5	-	0,73
	Bimba mod 3pl 1/br a 2,00	200	90	90	430	456	479	508	538	390	8	1 DECO 50*50	1,46
	Bimba mod 3pl 1/br a 1,80	180	90	90	410	435	457	484	513	370	7,8	1 DECO 50*50	1,31
	Bimba mod 2 pl 1/br	160	90	90	380	403	424	449	476	350	7,5	1 DECO 50*50	1,17
	Bimba mod 1pl 1/br a 1,10	110	90	90	300	318	334	354	375	270	5	1 DECO 50*50	0,80
	Bimba mod 1pl 1/br a 1,00	100	90	90	290	308	324	343	364	260	4,5	1 DECO 50*50	0,73
	Bimba mod 1pl 1/br a 0,90	90	90	90	280	297	312	331	351	250	4,3	1 DECO 50*50	0,66
	Bimba mod 1pl 1/br a 0,80	80	90	90	275	292	307	325	331	245	4,2	1 DECO 50*50	0,59
	Bimba mod 3pl s/br a 1,80	180	90	90	410	435	457	484	513	370	7,8	-	1,31
	Bimba mod 3pl s/br a 1,60	160	90	90	390	414	435	462	490	350	7,5	-	1,17
	Bimba mod 2pl s/br	140	90	90	360	382	402	426	452	330	7,2	-	1,02
	Bimba mod 1pl s/br a 0,90	90	90	90	280	297	312	331	351	250	5,3	-	0,66
	Bimba mod 1pl s/br a 0,80	80	90	90	270	287	302	320	339	240	4,8	-	0,59
	Bimba mod 1pl s/br a 0,70	70	90	90	260	276	290	307	325	230	4,8	-	0,51
	Bimba mod 1pl s/br a 0,60	60	90	90	255	271	285	302	320	225	4,2	-	0,44
100 	Bimba mod rincón	100	100	90	300	318	334	354	375	260	7	-	0,81
140 	Bimba terminal 1,40 x 0,9	140	90	90	300	318	334	354	375	260	7,5	-	1,02
115 	Bimba chaiselón 1,15 x 1,75	115	175	90	320	340	357	378	401	280	7,3	2 DECO 50*50	1,47

Tarifa por puntos/rate/tarif	medidas / measurements / mesures	Series telas / Fabrics series / Série de tissus					Metraje	Nº Decorativos	Cubicaje M <sup>3</sup>				
		Largo	Fondo	Altura	G/0	G/1				G/2	G/3	G/4	T Cliente
115 	Bimba chaiselón terminal 1,15 x 2,00	115	200	90	430	456	479	508	538	390	8	-	1,86



Bimba 3 pl. + chaiselongue en Melody 15  
Bimba , three seaters + chaiselong in melody 15 / Bimba 3 places + chaiselongue en melody 15

## Características técnicas / Technical characteristics / Caractéristiques techniques

- ESTRUCTURA: MADERA DE PINO
- RECOVERIMIENTO: ESPUMA DE POLIURETANO 1,5 CM
- ALMOHADAS ASIENTOS: ASIENTO HR 30 KG + GUATA
- ALMOHADAS RESPALDO: MICROFIBRA (TACTO PLUMAS)
- RESPALDOS: CABEZAL METALICO (NO RECLINABLE)+
- PATAS METÁLICAS
- STRUCTURE: PINE WOOD
- RECOVERY: LAYER OF POLYURETHANE FOAM , 1,5 CM
- SEAT CUSHION: SEAT HR FOAM 30 KG + WADDING
- BACK CUSHION: MICROFIBER (FEATHER TOUCH )
- LEGS: METALLIC LEGS
- STRUCTURE : BOIS DE PIN
- RECOUVREMENT : COUCHE DE MOUSSE POLYURETHANE 1.5 CM
- COUSSINS D'ASSISE : ASSISE HR 30 KG+ ONATE
- COUSSINS DE DOSSIER : MICROFIBRE (TACT PLUMES)
- DOSSIER : ENFOURCHÉ DANS UNE GRILLE METALLIQUE (FIXE)
- PIETEMENT : METALLIQUE

## Opciones de patas / Leg options / Options de jambe



El cambio de pata puede suponer un incremento en el precio. / Le changement de piètement peut entrainer un supplément sur le prix. / Change of legs could lead to a supplement.

**DVNI**<sup>®</sup>  
S T A R  
La marca que mejor te sienta







**DVN**<sup>®</sup>  
**S T A R**  
 La marca que mejor te sienta



# Tousi

Tousi 3 pl. en piel Sauvage cuero, respaldo en Gales naranja, riñonera en Fuji 19  
 Tousi, 3 seaters in leather Sauvage Cuero, backrest in Gales naranja (orange gales), kidney cushion in Fuji 19 / Tousi, 3 places en Cuir sauvage cuero, dossiers en Gales orange, cale-reins en fuji 19  
 Tousi pág. izquierda en Vitta 3041, Texas 15, decorativos en Dolxe 3006  
 Tousi opposit page in vitta 3041 and texas 15, decorative pillows in Dolxe 3006. / Tousi page gauche en Vitta 3041 et Texas 15, coussins deco en Dolxe 3006



Tousi 3 pl. + chaise longue en Texas 3, Vittu 3307, decorativos en Dolce 3006  
Tousi 3 seaters + chaise long in Vittu 3007 and Texas 03 , decorative pillows in Dolce 3006  
Tousi 3 pl + chaise longue en Vittu 3007 et Texas 03 , coussins deco en Dolce 3006

**Tousi**

# Tousi

Una solución única que se fundamenta en la estética de la originalidad, el equilibrio formal, imponiendo requisitos funcionales como son la movilidad y adaptabilidad en pro de optimizar el momento. Su versatilidad permite que los respaldos se desplacen o se inclinen en el momento querido. Es simplemente genial.

A unique solution based on the esthetics of originality, the formal balance ..imposing functional requirements such as mobility and adaptability in order to optimize the moment .Its versatility allows the backrest to shift or tilt when needed. It's simply great.

Une solution unique qui repose sur l'esthétique de l'originalité, de l'équilibre formel ..en imposant des conditions requises fonctionnelles est la mobilité et l'adaptabilité. Sa versatilité permet que les dossiers se déplacent ou s'inclinent au moment voulu. Il est tout simplement génial.



Tousi 3 pl. + chaiselongue en Texas 5, Vitta 3005, decorativos en Dolce 3006  
Tousi 3 pl + chaislong in vitta 3005 , texas 05 and decorative cushions in dolce 3006  
Tousi 3 pl + chaiselongue en vitta 3005 , texas 05 et coussins deco en dolce 3006









Tousi 3 pl. en piel Sauvage cuero, respaldo en Gales naranja, riñonera en Fuji 19  
Tousi, 3 seaters in leather Sauvage Cuero, backrest in Gales naranja (orange galles), kidney cushion in Fuji 19  
Tousi, 3 places en Cuir sauvage cuero, dossiers en Gales orange, cale-reins en fuji 19

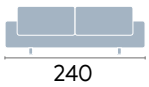
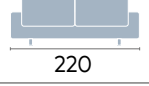
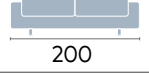

Tousi pág. izquierda en Vitta 3041, Texas 15, decorativos en Dolxe 3006 - Butaca Nube en Dolxe 3006  
Tousi in Vitta 3041, texas 15, pillows in dolxe 3006 - Nube chair in dolxe 3006 / Tousi en vitta 3041, texas 15, decos en dolxe 3006 - fauteuil Nube en dolxe 3006

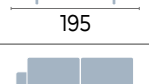
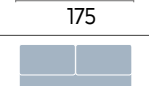
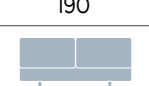
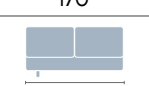
**Tousi**

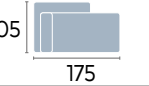
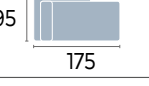
# Tousi

Tarifa por puntos/rate/tarif	medidas / measurements / mesures			Series telas / Fabrics series / Série de tissus							Series piel / Leather series / Série cuir				Metroaje	Nº Decorativos	Cubicaje M <sup>3</sup>
	Largo	Fondo	Altura	G/0	G/1	G/2	G/3	G/4	T Cliente	Piel 1	Piel 2	Piel 3	Piel 4				
90  240 Tousi 3 pl 2,40	240	102	90	600	630	661	700	742	570	840	924	1016	1118	11,6	2 DECO 50*50	1,98	
 220 Tousi 3 pl 2,20	220	102	90	580	610	645	683	729	551	810	891	980	1078	11,25	2 DECO 50*50	1,82	
 200 Tousi 2 pl	200	102	90	560	593	629	667	706	532	780	858	943	1038	11	2 DECO 50*50	1,66	
 110 Tousi 1 pl	110	102	90	398	421	447	474	502	378	550	605	665	732	8	-	0,91	
 215 Tousi mod 3 pl 1/b 2,15	215	102	90	580	610	645	683	724	551	810	891	980	1078	11	1 DECO 50*50	1,77	
 195 Tousi mod 3 pl 1/b 1,95	195	102	90	560	593	629	667	706	532	780	858	943	1038	10,5	1 DECO 50*50	1,61	
 175 Tousi mod 2 pl 1/b	175	102	90	540	567	601	637	675	513	750	825	907	998	10	1 DECO 50*50	1,45	
 190 Tousi mod 3 pl s/br 1,90	190	102	90	550	583	617	655	694	523	770	847	931	1024	9,5	-	1,57	
 170 Tousi mod 3 pl s/br 1,70	170	102	90	540	567	601	637	675	513	750	825	907	998	9,5	-	1,40	
 150 Tousi mod 2 pl s/br	150	102	90	510	540	573	607	643	485	710	781	859	945	9,5	-	1,24	
 120 Tousi mod 1 pl 1/b 120	120	102	90	420	445	471	500	530	399	570	627	689	757	8,5	-	0,99	
115  175 Tousi chaiselon 1,15 x 1,75	115	175	90	500	525	556	581	624	475	700	770	847	931	9	2 DECO 50*50	1,63	
105  175 Tousi chaiselon 1,05 x 1,75	105	175	90	480	504	534	566	600	456	680	748	822	904	8,8	2 DECO 50*50	1,49	
95  175 Tousi chaiselon 0,95 x 1,75	95	175	90	460	483	511	541	574	437	660	726	798	877	8,8	2 DECO 50*50	1,35	
112  112 Tousi rincón	112	112	90	510	540	573	607	643	485	710	781	859	945	7,5	-	1,02	

Tousi en Vitta 3041, Texas 15, decorativos en Dolxe 3006

Tousi en vitta 3041, texas 15, coussins deco en dolxe 3006 / Tousi in vitta 3041, texas 15, decorative cushion in dolxe 3006



Tousi en Vitta 3001, Texas 14, decorativos en Dolxe 3006

Tousi in vitta 3001, texas 14 and decorative cushions in dolxe 3006 / Tousi en vitta 3001, texas 14 et coussin deco en dolxe 3006

## Características técnicas / Technical characteristics / Caractéristiques techniques

- ESTRUCTURA: CHASIS METÁLICO
- RECUBRIMIENTO: GOMA Y VELOUR ENGUATADO
- ALMOHADAS ASIENTOS: GOMA HR 30 KG + COJINES PICADO VISCOELASTICA Y FIBRA SILICONADA
- ALMOHADAS RESPALDO: MICROFIBRA (TACTO DE PLUMA)
- COJINES ASIENTO: FIJOS
- RESPALDO FIJO
- PATAS METÁLICAS
- ESTE MODELO, SIEMPRE QUE VAYA TAPIZADO EN PIEL, NO INCLUIRÁ DECORATIVOS DE SERIE EN NINGUNA DE SUS MODULACIONES

- STRUCTURE: METALLIC FRAME
- RECOVERY: LAYER OF FOAM RECOVERED WITH WADDING
- COUSSINS D'ASSIS: MOUSSE 30 KG, COUSSINS REMBOURRÉS DE VISCO HACHÉ ET FIBRE DE SILICONE
- COUSSINS DE DOSSIER: MICROFIBRE (SENSATION PLUMES)
- BACKREST FIXED
- LEGS: METALLIC
- THIS MODELE DOESN'T INCLUDE PILLOWS WHEN MADE IN LEATHER

- STRUCTURE: CHÂSSIS MÉTALLIQUE
- RECOUVREMENT: COUCHE DE MOUSSE RECOUVERTE DE OUATE
- SEAT CUSHIONS: FOAM 30 KG, CUSHIONS FILLED WITH CHOPPED VISCO AND SILICONE FIBER
- BACKREST CUSHIONS: MICROFIBRE ( FEATHER TOUCH )DOSSIER:
- DOSSIER FIXE
- PIÈTEMENT: MÉTALLIQUE
- CE MODELE N'INCLUT PAS DE DECO LORSQU'IL EST FABRIQUE EN CUIR



**DVN**<sup>®</sup>  
S T A R  
La marca que mejor te sienta



# Fendy

Fendy 3 pl. en Victory 314, decorativos en Victory 271 y Stamford 314  
Fendy 3 seaters in Victory 314 , decorative pillows in 271 and Stamford 314 / Fendy 3 places en Victory 314 , coussins deco en victory 271 et en stamford 314  
Fendy pág. izquierda en Victory 347, decorativos en Victory 395  
Fendy opposit page in Victory 347 , decorative cushions in Victory 395 / Fendy en victory 347 , coussins deco en victory 395



Fendy

Fendy en Fiorella blanco C/423, decorativos en Fiorella blanco C/423  
FENDY in Fiorella blanco C/423 / FENDY en fiorella blanco, couleur 423

DVN®  
S T A R  
La marca que mejor te sienta



## Fendy

1. Fendy en Fiorella sky C/437, decorativos en Fiorella crudo C/431

*Fendy in fiorella sky c/437 + decorative pillows in fiorella crudo c/431 / fendy in fiorella sky c/437, coussins deco en fiorella crudo c/431*

2. Fendy en Victory 324, decorativos en Victory 348 y Stamford 324

*Fendy in victory 324 , decorative pillows in victory 348 and stamford 324 / Fendy in victory 324 , coussins deco en victory 348 et stamford 324*









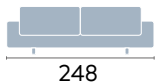
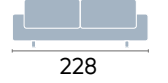
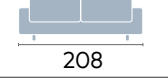
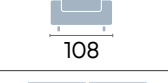
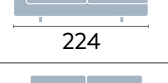
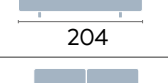

# Fendy

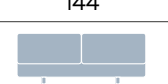
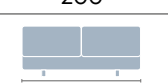
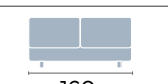

1. Fendy en Fiorella plata C/427, decorativos en Fiorella plata C/427  
Fendy in fiorella plata c/427, decorative pillows en fiorella plata c/427 / Fendy en fiorella plata couleur 427, coussins deco en fiorella plata c/427  
2. Fendy en Fiorella crudo C/431, decorativos en Fiorella crudo C/431  
Fendy in fiorella crudo c/431, decorative pillows en fiorella crudo c/431 / Fendy en fiorella crudo c/431, coussins deco en fiorella crudo c/431

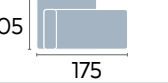
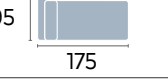
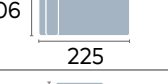
# Fendy

Tarifa por puntos/rate/tarif	medidas / measurements / mesures	Series telas / Fabrics series / Série de tissus									Metrage	Nº Decorativos	Cubiçaje M <sup>3</sup>
		Largo	Fondo	Altura	G/0	G/1	G/2	G/3	G/4	T Cliente			
92  248	Fendy 3 pl a 2,48	248	105	92	424	455	494	524	555	403	11,8	2 deco 50*50 + 2 riñoneras	1,80
 228	Fendy 3 pl a 2,28	228	105	92	404	436	470	498	528	384	11,6	2 deco 50*50 + 2 riñoneras	1,65
 208	Fendy 2 pl	208	105	92	385	417	455	482	511	366	10,3	2 deco 50*50 + 2 riñoneras	1,51
 108	Fendy 1 pl	108	105	92	308	339	370	392	416	293	8,5	1 deco 50*50 + 1 riñonera	0,78
 224	Fendy mod 3 pl a 2,24 1/b	224	105	92	404	436	470	498	528	384	11,8	1 deco 50*50 + 2 riñoneras	1,62
 204	Fendy mod 3 pl a 2,04 1/b	204	105	92	385	417	455	482	511	366	11,8	1 deco 50*50 + 2 riñoneras	1,48
 184	Fendy mod 2 pl 1/b	184	105	92	365	398	436	462	490	347	10,5	1 deco 50*50 + 2 riñoneras	1,34
 124	Fendy mod 1 pl a 1,24 1/b	124	105	92	314	346	376	399	422	298	7,9	1 deco 50*50 + 2 riñoneras	0,90
 114	Fendy mod 1 pl a 1,14 1/b	114	105	92	308	340	370	392	416	293	7,9	1 deco 50*50 + 2 riñoneras	0,83
 104	Fendy mod 1 pl a 1,04 1/b	104	105	92	304	336	364	386	409	289	7,5	1 deco 50*50 + 2 riñoneras	0,75
 144	Fendy mod 1 pl a 1,44 1/b	144	105	92	323	356	385	408	433	307	8,3	1 deco 50*50 + 2 riñoneras	1,04
 200	Fendy mod 3 pl a 2,00 s/b	200	105	92	385	417	455	482	511	366	10,6	2 riñoneras	1,45
 180	Fendy mod 3 pl a 1,80 s/b	180	105	92	365	398	433	459	487	347	10,2	2 riñoneras	1,31
 160	Fendy mod 2 pl a 1,60 s/b	160	105	92	347	378	414	439	465	330	8,6	2 riñoneras	1,16
 80	Fendy mod 1 pl a 0,80 s/b	80	105	92	270	300	320	339	360	257	4,8	2 riñoneras	0,58
115  175	Fendy chaiselón 1,15 x 1,75	115	175	92	385	414	455	482	511	366	8,5	2 deco 50*50	1,39
105  175	Fendy chaiselón 1,05 x 1,75	105	175	92	380	408	447	474	502	361	8,1	2 deco 50*50	1,27
95  175	Fendy chaiselón 0,95 x 1,75	95	175	92	371	399	437	463	491	352	7,7	2 deco 50*50	1,15
106  225	Fendy chaiselón terminal 1/b	106	225	92	390	425	460	488	517	371	10,8	1 deco 50*50	1,64
110  110	Fendy rincón	110	110	92	347	378	414	439	465	330	7,5	-	0,83



Fendy en Fiorella plata C/427, decorativos en Fiorella plata C/427  
Fendy in fiorella plata c/427, decorative pillows en fiorella plata c/427  
Fendy en fiorella plata couleur 427, coussins deco en fiorella plata c/427



Fendy 3 pl. en Victory 314, decorativos en Victory 271 y Stamford 314  
Fendy 3 seaters in victory 314, decorative pillows en victory 271 / Fendy 3 places en victory 314, coussins deco en victory 271

## Características técnicas / Technical characteristics / Caractéristiques techniques

- ESTRUCTURA: MADERA DE PINO.
- RECUBRIMIENTO: ESPUMA DE POLOURETANO DE 1,50 CM.
- ALMOHADAS ASIENTOS: GOMA HR 33 KG + COJÍN DE PICADO DE VISCOELASTICA Y FIBRA SILICONADA.
- ALMOHADAS RESPALDO: MICROFIBRA.
- DECORATIVOS
- PATAS: MADERA DE FRESNO.
- STRUCTURE: PINE WOOD
- RECOVERY: LAYER OF POLYURETHANE OF 1.50 CM
- SEAT CUSHION: FOAM OF 33 KG + DOUBLE LAYER OF VISCOELASTIC AND SILICONE FIBER
- BACK CUSHION: MICROFIBER
- LEGS: ASH WOOD
- STRUCTURE: BOIS DE PIN
- RECOUVREMENT: COUCHE DE POLYURÉTHANE DE 1.50CM
- COUSSIN D'ASSIS: MOUSSE DE 33 KG + DOUBLE COUCHE DE VISCOELASTIC ET FIBRE DE SILICONE.
- COUSSIN DE DOSSIER: MICROFIBRE
- PIÈTEMENT: BOIS DE FRÊNE

## Opciones de patas / Leg options / Options de jambe

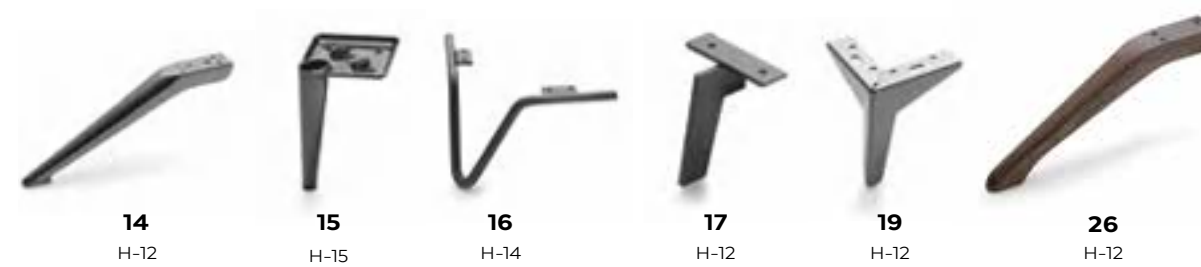

El cambio de pata puede suponer un incremento en el precio. / Le changement de piètement peut entrainer un supplément sur le prix. / Change of legs could lead to a supplement.



**DVN**<sup>®</sup>  
S T A R  
La marca que mejor te sienta



# Toscana

Toscana en Secreto Crema, decorativos en Atlas C-16, C-18 y C-17  
Toscana in Secreto Crema, coussins deco en Atlas C-16, C-18 et C-17  
Toscana pág. izquierda en Secreto Blanco  
Toscana opposit page in Secreto Blanco / Toscana en Secreto Blanco



Toscana en Secreto Blanco  
*Toscana in Secreto Blanco / Toscana en Secreto Blanco*

# Toscana













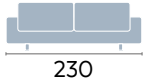
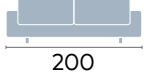
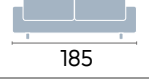

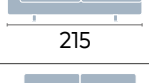

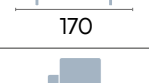
Toscana en Secreto Tostado, decorativos en Atlas C-16, C-18 y C-15  
*Toscana in Secreto Tostado, decorative cushions in Atlas C-16, C-18 and C-15 / Toscana in Secreto Tostado, coussins deco en Atlas C-16, C-18 et C-15*

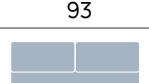
# Toscana

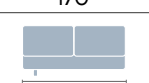

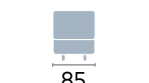
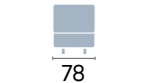
Toscana en Secreto blanco, decorativos en Atlas C-17, C-16 y C-15  
Toscana in Secreto blanco, decorative cushions in Atlas C-17, C-16 and C-15 / Toscana en Secreto blanco, coussins deco en Atlas C-17, C-16 et C-15

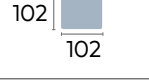
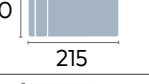
# Toscana

Tarifa por puntos/rate/tarif	medidas / measurements / mesures	Series telas / Fabrics series / Série de tissus									Metroje	N° Decorativos	Cubicaje M <sup>3</sup>
		Largo	Fondo	Altura	G/0	G/1	G/2	G/3	G/4	T Cliente			
 230	TOSCANA 3 PL A 2,30	230	110	80	495	532	577	612	649	465	12,5	2 DECO 55*55 + 2 DECO 45*45	1,52
 200	TOSCANA 3 PL A 2,00	200	110	80	472	510	550	583	618	443	11	2 DECO 55*55 + 2 DECO 45*45	1,32
 185	TOSCANA 2 PL	185	110	80	450	487	532	564	598	423	9,5	2 DECO 55*55 + 2 DECO 45*45	1,22
 108	TOSCANA 1 PL	108	110	80	360	396	432	458	485	338	6,7	1 DECO 55*55 + 1 DECO 45*45	0,71
 215	TOSCANA MOD 3 PL A 2,15 1/BR	215	110	80	472	510	550	583	618	443	12	2 DECO 55*55 + 2 DECO 45*45	1,42
 185	TOSCANA MOD 3 PL A 1,85 1/BR	185	110	80	450	487	532	564	598	423	9,7	2 DECO 55*55 + 2 DECO 45*45	1,22
 170	TOSCANA MOD 2 PL 1/BR	170	110	80	427	465	510	541	573	401	9	2 DECO 55*55 + 2 DECO 45*45	1,13
 115	TOSCANA MOD 1 PL A 1,15 1/BR	115	110	80	370	406	442	468	495	348	7,5	1 DECO 55*55 + 1 DECO 45*45	0,76
 100	TOSCANA MOD 1 PL A 1,00 1/BR	100	110	80	360	386	422	448	475	328	6,6	1 DECO 55*55 + 1 DECO 45*45	0,66
 93	TOSCANA MOD 1 PL A 0,93 1/BR	93	110	80	350	376	410	438	465	318	6,2	1 DECO 55*55 + 1 DECO 45*45	0,62
 200	TOSCANA MOD 3 PL 2,00 S/BR	200	110	80	450	487	528	560	594	423	11,3	2 DECO 55*55 + 2 DECO 45*45	1,32
 170	TOSCANA MOD 3 PL 1,70 S/BR	170	110	80	427	465	505	535	567	401	10,8	2 DECO 55*55 + 2 DECO 45*45	1,13
 155	TOSCANA MOD 2 PL S/BR	155	110	80	405	442	483	512	543	380	8,8	2 DECO 55*55 + 2 DECO 45*45	1,02
 100	TOSCANA MOD 1 PL S/B	100	110	80	335	371	393	415	439	310	6,3	1 DECO 55 *55	0,66
 85	TOSCANA MOD 1 PL S/B	85	110	80	325	361	383	405	429	306	5,9	1 DECO 55 *55	0,56
 78	TOSCANA MOD 1 PL S/B	78	110	80	315	351	373	395	419	296	5,5	1 DECO 55 *55	0,52
 110	TOSCANA MOD RINCON	110	110	80	405	442	483	512	543	385	7,8	1 DECO 55 *55	0,73
 102	TOSCANA POUFF	102	102	40	225	250	275	292	310	214	4	-	0,32
 215	TOSCANA CHAISELON 1,10 X 2,15	110	215	80	472	510	550	583	618	423	11,5	2 DECO 55*55 + 1 DECO 45*45	1,42
 185	TOSCANA CHAISELON 1,10 X 1,85	110	185	80	450	487	532	564	598	380	11	2 DECO 55*55 + 1 DECO 45*45	1,11



Toscana en Secreto Arena, decorativos en Atlas C-16, C-18 y C-17 / Toscana in Secreto Arena, coussins deco en Atlas C-16, C-18 et C-17

## Características técnicas / Technical characteristics / Caractéristiques techniques

- ESTRUCTURA: MADERA DE PINO MAZION Y DESENFUNDABLE
- ALMOHADAS ASIENTOS: ASIENTOS BULFLEX
- ALMOHADAS RESPALDO: MICROFIBRA (TACTO PLUMAS)
- PATAS DE SERIE: METALICAS EN ACERO INOXIDABLE.
- OPCION PATAS: MADERA NATURAL
- STRUCTURE: PINEWOOD
- SEAT CUSHION: FILLED WITH BULFLEX FOAM
- BACK CUSHION: MICROFIBRE (FEATHER TOUCH)
- STANDARD LEGS: STAINLESS STEEL
- LEGS OPTION: NATURAL WOODEN LEGS
- STRUCTURE: BOIS DE PIN
- COUSSINS D'ASSISE: ASSISES EN MOUSSE BULFLEX
- COUSSINS DE DOSSIER: MICROFIBRE SENSATION PLUME
- PIETEMENT STANDARD: ACIER INOXIDABLE
- OPTION PIETEMENT: PIEDS BOIS COULEUR NATURELLE
- ALMOHADA DE ASIENTO DE MODULACIÓN EN UNA SOLA PIEZA.
- EL MODELO ES TOTALMENTE DESENFUNDABLE, ALMOHADAS DE ASIENTO Y RESPALDO Y TAMBIÉN ESTRUCTURA.
- EN ESTE MODELO NO SE PODRÁ REALIZAR REDUCCIÓN DE BRAZOS EN NINGUNA DE SU MODULACIONES.
- SEAT CUSHION OF SOFA WITH ONE ARM IS MADE IN ONE PIECE
- THE SOFA COVER IS TOTALLY REMOVABLE, SEAT CUSHION, BACK CUSHION AND FRAME
- THERE IS NO POSSIBILITY OF ARM REDUCTION IN THIS MODEL
- LE COUSSIN D'ASSISE DU BATAARD EST TOUJOURS FAIT EN UNE SEULE PIECE.
- CE MODELE EST ENTIEREMENT DEHOUSSABLE, COUSSINS D'ASSISE, DE DOSSIER ET STRUCTURE.
- LES ACCOUDOIRS DE CE MODELE NE PEUVENT EN AUCUN CAS ETRE REDUITS.

## Opciones de patas / Leg options / Options de jambe



**33**  
H-7,5

El cambio de pata puede suponer un incremento en el precio. / Le changement de piètement peut entrainer un supplément sur le prix. / Change of legs could lead to a supplement.



**DVN**<sup>®</sup>  
**S T A R**  
 La marca que mejor te sienta



**Dyor**

Dyor 3 pl. + chaiselongue en Boston Toffeee, piel Módena Tortora, decorativos en Stamford 56  
 Dyor 3 seaters + chaiselong in boston Toffeee and modena tortora leather , decorative cushions in stamford 56 / Dyor 3 places + chaiselongue en boston toffeee t cuir modena tortora coussins deco en stamford 56  
 Dyor 3 pl. + chaiselongue en Boston Toffeee t cuir modena tortora coussins deco en stamford 56  
 pág. izquierda en Boston Ash, piel Módena Mostarda, decorativos en Stamford 314  
 Dyor opposit page in boston Ash and modena mostarda leather , decorative cushions in stamford 314 / Dyor page gauche , revêtu de Boston ash et cuir modena mostarda , coussins deco en satmford 314



Dyor en Boston Ash, piel Módena Mostarda, decorativos en Stamford 314  
Dyor opposit page in boston Ash and modena mostarda leather , decorative cushions in stamford 314  
Dyor page gauche , revêtu de Boston ash et cuir modena mostarda , coussins deco en satmford 314

## Dyor

Dyor es dueña de la sensibilidad, la sutileza, la belleza de la armonía y el rico movimiento de las curvas. Muy bien resuelta, acogedora y diferente. Única, de brazos singulares concebidos para arropar a los decorativos con gracia y elegancia. De diseño inesperadamente práctico y envolvente.

Dyor owns sensibility, subtlety, the beauty of harmony and poetic curves. Very well made, it's welcoming, different and unique in its genre. The unique arm is designed to wrap the decorative with grace and elegance. It is unexpectedly practical and engaging.

Dyor est maîtresse de la sensibilité ,la subtilité, la beauté et l'harmonie. Ces riches courbes poétiques font de Dyor une exclusivité en matière d'accueil et de différence. Dyor est unique avec un bras singulier conçu pour couvrir les coussins décoratifs avec grâce et élégance. Dyor est conçu en un design très inspiré, pratique et envoûtant.











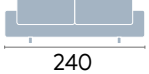
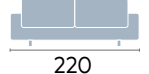
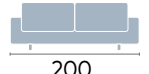

Dyor en Boston Toffeee, piel Módena Tortora, decorativos en Stamford 56  
Dyor 3 seaters + chaiselong in boston Toffeee and modena tortora leather, decorative cushions in stamford 56  
Dyor 3 places + chaiselongue en boston toffeee t cuir modena tortora coussins deco en stamford 56



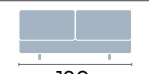

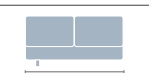
Dyor en Boston Ash, piel Módena Mostarda, decorativos en Stamford 314 - Butaca Taycan en piel Módena Mostarda  
Dyor in boston Ash fabric and modena leather mostarda, pillows in stamford 314, Taycan chair in modena leather mostarda  
Dyor, revetu de Boston Ash et de cuir modena mostarda, coussins deco en stamford 314, fauteuil Taycan en cuir modena mostarda

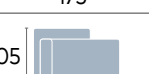
# Dyor

Tarifa por puntos/rate/tarif	medidas / measurements / mesures			Series telas / Fabrics series / Série de tissus							Series piel / Leather series / Série cuir				Metroje	Nº Decorativos	Cubicaje M <sup>3</sup>
	Largo	Fondo	Altura	G/0	G/1	G/2	G/3	G/4	T Cliente	Piel 1	Piel 2	Piel 3	Piel 4				
 240	Dyor 3 pl 2,40	240	102	90	600	630	661	700	742	570	840	924	1016	1118	11,6	2 DECO 50*50	1,98
 220	Dyor 3 pl 2,20	220	102	90	580	610	645	683	729	551	810	891	980	1078	11,25	2 DECO 50*50	1,82
 200	Dyor 2 pl	200	102	90	560	593	629	667	706	532	780	858	943	1038	11	2 DECO 50*50	1,66
 110	Dyor 1 pl	110	102	90	398	421	447	474	502	378	550	605	665	732	8	-	0,91
 215	Dyor mod 3 pl 1/b 2,15	215	102	90	580	610	645	683	724	551	810	891	980	1078	11	1 DECO 50*50	1,77
 195	Dyor mod 3 pl 1/b 1,95	195	102	90	560	593	629	667	706	532	780	858	943	1038	10,5	1 DECO 50*50	1,61
 175	Dyor mod 2 pl 1/b	175	102	90	540	567	601	637	675	513	750	825	907	998	10	1 DECO 50*50	1,45
 190	Dyor mod 3 pl s/br 1,90	190	102	90	550	583	617	655	694	523	770	847	931	1024	9,5	-	1,57
 170	Dyor mod 3 pl s/br 1,70	170	102	90	540	567	601	637	675	513	750	825	907	998	9,3	-	1,40
 150	Dyor mod 2 pl s/br	150	102	90	510	540	573	607	643	485	710	781	859	945	9	-	1,24
 120	Dyor mod 1 pl 1/b 120	120	102	90	420	445	471	500	530	399	570	627	689	757	8,5	-	0,99
 115	Dyor chaiselon 1,15 x 1,75	115	175	90	500	525	556	581	624	475	700	770	847	931	9	2 DECO 50*50	1,63
 105	Dyor chaiselon 1,05 x 1,75	105	175	90	480	504	534	566	600	456	680	748	822	904	8,8	2 DECO 50*50	1,49
 95	Dyor chaiselon 0,95 x 1,75	95	175	90	460	483	511	541	574	437	660	726	798	877	8,5	2 DECO 50*50	1,35
 112	Dyor rincón	112	112	90	510	540	573	607	643	485	710	781	859	945	7,5	-	1,02



Dyor en Boston Toffee, piel Módena Tortora, decorativos en Stamford 56 / Dyor en Boston toffee and modena leather tortora, pillows in stamford 56 / Dyor en Boston toffee et cuir modena tortora, coussins deco en stamford 56

## Características técnicas / Technical characteristics / Caractéristiques techniques

- ESTRUCTURA: CHASIS METÁLICO
- RECUBRIMIENTO: ESPUMA DE POLIURETANO 1,5 CM
- ALMOHADAS ASIENTOS: ASIENTOS HR 30KG + COJIN PICADO VICOELASTICA Y FRIBRA SILICONADA.
- ALMOHADAS RESPALDO: MICROFIBRA (TACTO PLUMAS)
- RESPALDOS: CABEZAL METALICO
- PATAS METÁLICAS
- ESTE MODELO, SIEMPRE QUE VAYA TAPIZADO EN PIEL, NO INCLUIRÁ DECORATIVOS DE SERIE EN NINGUNA DE SUS MODULACIONES

- STRUCTURE: METALLIC FRAME
- RECOVERY: LAYER OF POLYURETHANE 1,5 CM
- SEAT CUSHION: FOAM 30 KG, CUSHIONS FILLED WITH CHOPPED VISCO AND SILICONE FIBER
- BACK CUSHION: MICROFIBER FEATHER TOUCH
- STRADDLED IN A METAL GRID
- LEGS: METALLIC
- THERE IS NO PILLOW INCLUDED IN THIS MODELE IF MADE IN LEATHER

- STRUCTURE: CHÂSSIS MÉTALLIQUE
- RECOUVREMENT: COUCHE DE POLYURÉTHANE DE 1,5 CM
- COUSSIN D'ASSISE: MOUSSE 30 KG, COUSSINS REMBOURRÉS DE VISCO HACHÉ ET FIBRE DE SILICONE
- COUSSIN DE DOSSIER: MICROFIBRE TACT PLUMES
- DOSSIER ENFOURCHÉ DANS UNE GRILLE MÉTALLIQUE
- PIÈTEMENT: MÉTALLIQUE
- CE MODELE N'INCLUT PAS DE DECO LORSQU'IL EST FABRIQUÉ EN CUIR



**DVN**<sup>®</sup>  
S T A R  
La marca que mejor te sienta



# Valenciaga

Valenciaga 3 pl. en Jaipur Natural  
Valenciaga 3 seaters in Jaipur Natural / Valenciaga 3 places revêtu de Jaipur Natural  
Valenciaga pág. izquierda en Jaipur Arena  
Valenciaga opposit page in Jaipur Arena / Valenciaga page gauche, revêtu de Jaipur Arena



## Valenciaga











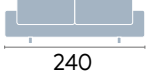
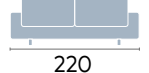
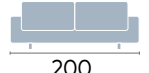

Valenciaga 3 pl. + chaiselongue en Guess Blanco  
Valenciaga 3 seater + chaiselongue in Guess Blanco / Valenciaga 3 places + chaiselongue revêtu de Guess Blanco

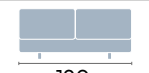

Valenciaga 3 pl. + chaiselongue en Guess Blanco  
Valenciaga 3 seater + chaiselongue in Guess Blanco / Valenciaga 3 places + chaiselongue revêtu de Guess Blanco

**Valenciaga**

# Valenciaga

Tarifa por puntos/rate/tarif	medidas / measurements / mesures	Series telas / Fabrics series / Série de tissus					Series piel / Leather series / Série cuir				Metroje	Nº Decorativos	Cubicaje M <sup>3</sup>				
		Largo	Fondo	Altura	G/0	G/1	G/2	G/3	G/4	T Cliente				Piel 1	Piel 2	Piel 3	Piel 4
100  240	Valenciaga 3 pl 2,40	240	102	100	600	630	661	700	742	570	882	924	1016	1118	11,6	2 DECO 50*50	2,21
 220	Valenciaga 3 pl 2,20	220	102	100	545	610	645	683	729	551	851	891	980	1078	11,25	2 DECO 50*50	2,02
 200	Valenciaga 2 pl	200	102	100	526	593	629	667	706	532	819	858	943	1038	11	2 DECO 50*50	1,84
 110	Valenciaga 1 pl	110	102	100	374	421	447	474	502	378	578	605	665	732	8	-	1,01
 215	Valenciaga mod 3 pl 1/b 2,15	215	102	100	545	610	645	683	724	551	851	891	980	1078	11	1 DECO 50*50	1,97
 195	Valenciaga mod 3 pl 1/b 1,95	195	102	100	526	593	629	667	706	532	819	858	943	1038	10,5	1 DECO 50*50	1,79
 175	Valenciaga mod 2 pl 1/b	175	102	100	508	567	601	637	675	513	788	825	907	998	10	1 DECO 50*50	1,61
 190	Valenciaga mod 3 pl s/br 1,90	190	102	100	517	583	617	655	694	523	809	847	931	1024	9,5	-	1,75
 170	Valenciaga mod 3 pl s/br 1,70	170	102	100	508	567	601	637	675	513	788	825	907	998	9,5	-	1,56
 150	Valenciaga mod 2 pl s/br	150	102	100	479	540	573	607	643	485	746	781	859	945	9,5	-	1,38
 120	Valenciaga mod 1 pl 1/b 120	120	102	100	395	445	471	500	530	399	599	627	689	757	8,5	-	1,10
115  175	Valenciaga chaiselon 1,15 x 1,75	115	175	100	470	525	556	581	624	475	735	770	847	931	9	2 DECO 50*50	1,81
105  175	Valenciaga chaiselon 1,05 x 1,75	105	175	100	451	504	534	566	600	456	714	748	822	904	8,8	2 DECO 50*50	1,66
95  175	Valenciaga chaiselon 0,95 x 1,75	95	175	100	432	483	511	541	574	437	693	726	798	877	8,8	2 DECO 50*50	1,49
112  112	Valenciaga rincón	112	112	100	479	540	573	607	643	485	746	781	859	945	7,5	-	1,13



1. Valenciaga 3 pl. en Jaipur Cerúleo  
*Valenciaga 3 seaters in Jaipur Cerúleo / Valenciaga 3 places revêtu de Jaipur Cerúleo*  
2. Valenciaga 3 pl. en Jaipur Gris  
*Valenciaga 3 seaters in Jaipur Gris / Valenciaga 3 places revêtu de Jaipur Gris*

## Características técnicas / Technical characteristics / Caractéristiques techniques

- ESTRUCTURA: BASTIDOR METÁLICO CON MUELLE ZIG-ZAG
- RECUBRIMIENTO: GOMA 1,5 CM Y FLOCA 200 GR
- ALMOHADAS ASIENTOS: BULFLEX
- ALMOHADAS RESPALDO: MICROFIBRA (TACTO PLUMAS)
- RESPALDOS: CABEZAL METÁLICO
- PATAS METÁLICAS
- ESTE MODELO, SIEMPRE QUE VAYA TAPIZADO EN PIEL, NO INCLUIRÁ DECORATIVOS DE SERIE EN NINGUNA DE SUS MODULACIONES

- STRUCTURE: METALLIC FRAME ZIG-ZAG
- RECOVERY: A LAYER OF FOAM 1,5 CM AND FIBRE
- SEAT CUSHION: BULFLEX
- BACK CUSHION: MICROFIBER FEATHER TOUCH STRADDLED IN A METAL GRID
- LEGS: METALLIC
- THERE IS NO PILLOW INCLUDED IN THIS MODELE IF MADE IN LEATHER

- STRUCTURE: CHÂSSIS MÉTALLIQUE ZIG-ZAG
- RECOUVREMENT: UNE COUCHE DE MOUSSE DE 1,5 CM ET DE FIBRE.
- COUSSIN D'ASSISE: BULFLEX
- COUSSIN DE DOSSIER: MICROFIBRE TACT PLUMES
- DOSSIER ENFOURCHÉ DANS UNE GRILLE MÉTALLIQUE
- PIÈTEMENT: MÉTALLIQUE
- CE MODELE N'INCLUT PAS DE DECO LORSQU'IL EST FABRIQUÉ EN CUIR



**OVN**<sup>®</sup>  
**S T A R**

La marca que mejor te sienta



**DVN**<sup>®</sup>  
S T A R  
La marca que mejor te sienta



Eden en Secreto océano  
Eden in secreto ocean / Eden en secreto ocean  
Eden pág. izquierda en Secreto tostado  
Eden in secreto tostado / Eden en secreto tostado

**Eden**

---





## Eden

Eden, clásico en su frente, moderno y renovador por su retaguardia. Super elegante, maravilloso, que te envuelve y acomoda contundemente. Un gran abrazo de aprecio y armonía. Clara sensación de descanso sereno y seguridad. Diseño de última generación con perfectos acabados a la medida de tu exigencia en bien-estar.

Modern in its front side and classic by its rear. Super sleek, wonderfully flat, wrap-around and flatter. A great embrace of appreciation and harmony. Clear sensibility of peaceful rest and security.

Il est à la fois classique et moderne, rénovateur de par son arrière-garde, il est super élégant et surprend sur tous les plans. Il nous transmet sécurité et paix intérieure.











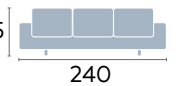
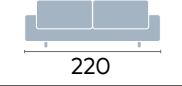
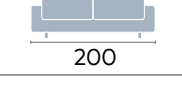
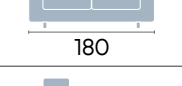

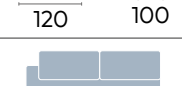
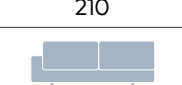
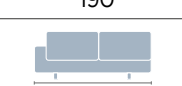
Eden en Secreto coral  
Eden in secreto coral / Eden en secreto coral

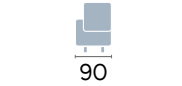
Eden

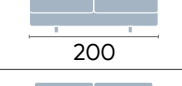
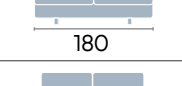
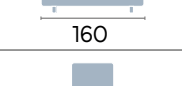
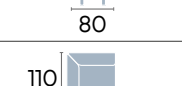
**DVN**  
S T A R  
La marca que mejor te sienta

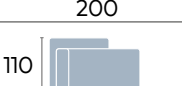
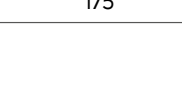
# Eden

Tarifa por puntos/rate/tarif	medidas / measurements / mesures	Series telas / Fabrics series / Série de tissus									Metrage	Nº Decorativos	Cubicaje M <sup>3</sup>
		Largo	Fondo	Altura	G/0	G/1	G/2	G/3	G/4	T Cliente			
85 	Eden 3 cabezales a 2,40	240	100	85	533	571	621	658	697	506	15	2 DECO 50*50 + 2 RIÑONERAS DE 30*50	1,84
	Eden 3 pl a 2,20	220	100	85	497	534	579	614	651	472	14,2	2 DECO 50*50 + 2 RIÑONERAS DE 30*50	1,68
	Eden 3 pl a 2,00	200	100	85	473	512	552	614	651	449	13,2	2 DECO 50*50 + 2 RIÑONERAS DE 30*50	1,53
	Eden 2 pl	180	100	85	452	489	534	585	620	429	12,4	2 DECO 50*50 + 2 RIÑONERAS DE 30*50	1,38
	Eden 1 pl c/80	100	100	85	361	399	433	459	487	343	7,2	1 DECO 50*50 + 1 RIÑONERA DE 30*50	0,77
	Eden 1 pl c/90	110	100	85	365	403	440	466	494	347	6,8	1 DECO 50*50 + 1 RIÑONERA DE 30*50	0,85
	Eden 1 pl c/100	120	100	85	373	410	448	475	504	354	7,4	1 DECO 50*50 + 1 RIÑONERA DE 30*50	0,92
	Eden mod. 3 Pl a 2,10 1/b	210	100	85	473	512	552	585	620	449	11,8	1 DECO 50*50 + 2 RIÑONERA DE 30*50	1,61
	Eden mod. 3 Pl a 1,90 1/b	190	100	85	452	489	534	566	600	429	9,4	1 DECO 50*50 + 2 RIÑONERA DE 30*50	1,46
	Eden mod. 2 Pl 1/b	170	100	85	428	467	512	543	576	407	9,1	1 DECO 50*50 + 2 RIÑONERA DE 30*50	1,31
	Eden mod. 1 Pl a 1,10 1/b	110	100	85	369	406	440	466	494	351	6,3	1 DECO 50*50 + 1 RIÑONERA DE 30*50	0,85
	Eden mod. 1 Pl a 1,00 1/b	100	100	85	361	399	434	460	488	343	6,2	1 DECO 50*50 + 1 RIÑONERA DE 30*50	0,77
	Eden mod. 1 Pl a 0,90 1/b	90	100	85	357	394	427	453	480	339	5,8	1 DECO 50*50 + 1 RIÑONERA DE 30*50	0,69
	Eden mod. 1 Pl a 1,30 1/b	130	100	85	379	417	452	479	508	360	7,9	1 DECO 50*50 + 1 RIÑONERA DE 30*50	1,00
	Eden mod. 3 Pl s/b 2,00	200	100	85	452	489	534	566	600	429	10,5	2 RIÑONERAS DE 30*50	1,53
	Eden mod. 3 Pl s/b 1,80	180	100	85	428	467	508	538	570	407	9,8	2 RIÑONERAS DE 30*50	1,38
	Eden mod. 2 Pl s/b	160	100	85	407	443	485	514	545	387	8,2	2 RIÑONERAS DE 30*50	1,22
	Eden mod. 1 Pl s/b	80	100	85	317	353	375	398	422	301	4,4	1 RIÑONERA DE 30*50	0,61
	Eden mod. Rincón 1,10*1,10	110	110	85	407	443	485	514	545	387	6	-	0,93
	Eden chaiselongue terminal	100	200	85	452	486	534	566	600	429	10	1 RIÑONERA DE 30*50	1,53
	Eden chaiselongue 1,10*1,75	110	175	85	446	480	524	555	588	424	8,4	2 DECO 50*50	1,48

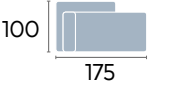
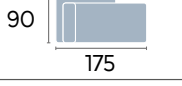
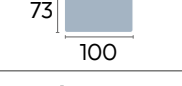
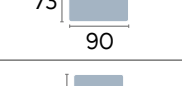
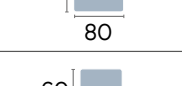
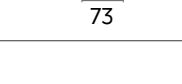
Tarifa por puntos/rate/tarif	medidas / measurements / mesures	Series telas / Fabrics series / Série de tissus									Metrage	Nº Decorativos	Cubicaje M <sup>3</sup>
		Largo	Fondo	Altura	G/0	G/1	G/2	G/3	G/4	T Cliente			
100 	Eden chaiselongue 1,00*1,75	100	175	85	435	468	513	544	577	413	8,2	2 DECO 50*50	1,34
90 	Eden chaiselongue 0,90*1,75	90	175	85	463	497	545	578	613	440	8	2 DECO 50*50	1,21
73 	Eden Pouf 1,00 *0,73	100	73	44	222	245	267	283	300	211	2,6	2 DECO 50*50	0,30
73 	Eden Pouf 0,90 *0,73	90	73	44	211	234	256	271	287	200	2,5	-	0,30
73 	Eden Pouf 0,80 *0,73	80	73	44	201	222	234	248	263	191	2,4	-	0,20
60 	Eden Pouf 0,73 *0,60	73	60	44	191	214	225	239	253	181	2,3	-	0,20



Eden en Secreto cuarzo  
Eden in secreto cuarzo / Eden en secreto cuarzo

## Características técnicas / Technical characteristics / Caractéristiques techniques

- ESTRUCTURA: BASTIDOR METÁLICO (CON MUELLES ZIG-ZAG)
- ESTRUCTURA BRAZOS Y RESPALDOS: MADERA CON PARTICULAS
- ALMOHADAS ASIENTOS: BULFLEX
- ALMOHADAS RESPALDO: FIBRA DE MICORFIBRA TACTO PLUMA
- PATAS DE SERIE: METALICAS
- STRUCTURE: CHÂSSIS MÉTALLIQUE (AVEC RESSORT EN ZIGZAG).
- ACCOUDOIRS ET DOSSIER EN BOIS DE PARTICULES.
- COUSSIN D'ASSISE: BULFLEX
- COUSSIN DE DOSSIER: FIBRE DE MICROFIBRE TACT PLUME.
- PIÈTEMENT EN MÉTAL.
- STRUCTURE METALLIC FRAME WITH ZIGZAG SPRINGS.
- ARMREST AND BACKREST IN WOOD PARTICLES.
- SEAT CUSHION: BULFLEX
- BACK CUSHION FIBER OF MICROFIBER FEATHER TOUCH.
- LEGS: METAL OPTION.

## Opciones de patas / Leg options / Options de jambe



10 H-14 H-12      11 H-14 H-12      12 H-14      15 H-15 H-12

El cambio de pata puede suponer un incremento en el precio. / Le changement de piètement peut entraîner un supplément sur le prix. / Change of legs could lead to a supplement.

## Bastidor metálico

/ Metallic frame / Chassis métallique





**DVN**<sup>®</sup>  
**S T A R**  
 La marca que mejor te sienta



# Pradas

Pradas en Flint 20, decorativos en Flint 43 y Velvet 73  
 Pradas in Flint 20, pillows in flint 43 and velvet 73 / Pradas in Flint 20, pillows in flint 43 and velvet 73  
 Pradas pág. izquierda en Flint 95, decorativos en Velvet 14 y Velvet 89  
 Pradas in Flint 95, pillows in velvet 14 and velvet 89 / Pradas en flint 95, coussins deco en velvet 14 et velvet 89



## Pradas

1. Pradas rinconera en Flint 31, decorativos en Velvet 84 y Velvet 86  
Pradas angle en Flint 31, , coussins deco en velvet 84 et velvet 86 / Pradas Corner , in flint 31 , pillows in velvet 84 and velvet 86  
2. Pradas pág. izquierda en Flint 02, decorativos en Velvet 73 y Velvet 89  
Pradas in flint 02, pillows in velvet 73 and velvet 89 / Pradas en flint 02, coussins deco en velvet 73 and velvet 89



## Pradas

Contundentes volúmenes de reminiscencias arquitectónicas, con equilibrio de líneas donde predominan las horizontales para darle un temperamento sosegado, sereno, por otro lado. Pradas es idóneo para ambientes de alto nivel de decoración, adaptándose por otra parte a conceptos clásicos, neo-clásicos o contemporáneos, dependiendo del acabado que se le dé.

Strong volume with architectural reminiscences, balanced lines where prevail horizontal lines to offer a calm and relaxed atmosphere. Pradas is ideal for high level environment decoration, adapting to classic, neo-classic or contemporary concepts, depending on endings of the model.

De puissants volumes de réminiscences architecturales, avec des lignes équilibrées ou les horizontales prédominant pour lui donner un tempérament calme et serein. Pradas est idéal pour des environnements de haut niveau de décoration, Il s'adapte par ailleurs aux concepts classiques, neoclassique, ou contemporains dépendant de sa finition.









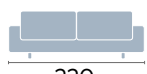
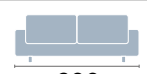
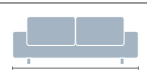

Pradas rinconera en Flint 43, decorativos en Velvet 60, Velvet 89 y Velvet 85  
Pradas canapé d'angle en flint 43 , coussins deco en Velvet 60 , velvet 89 et velvet 85  
Pradas corner upholstered in Flint 43, pillows in velvet 60, 89 and 85



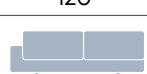
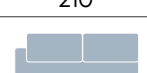
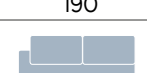



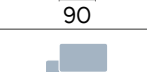
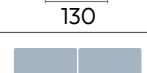
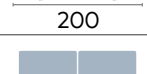
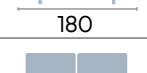
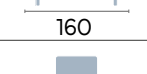
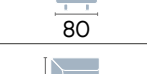

# Pradas

Pradas rinconera en Velvet 84, decorativos en Velvet 84 y Velvet 14 - Butaca Pradas en Velvet 14  
Pradas corner in velvet 84, pillows in velvet 84 and velvet 14 Pradas chairs in velvet 14 / Pradas canapé d'angle en velve t 84, coussins deco en velvet 84 et velvet 14. Fauteuils Pradas en velvet 14

# Pradas

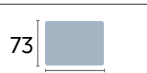
Tarifa por puntos/rate/tarif	medidas / measurements / mesures	Series telas / Fabrics series / Série de tissus									Metroje	Nº Decorativos	Cubiçaje M³
		Largo	Fondo	Altura	G/0	G/1	G/2	G/3	G/4	T Cliente			
85 	Pradas 3 cabezales a 2,40	240	100	85	549	588	640	678	719	522	15	2 HILTON + 2 RIÑONERAS	1,84
	Pradas 3 pl a 2,20	220	100	85	512	550	596	632	670	486	14	2 HILTON + 2 RIÑONERAS	1,68
	Pradas 3 pl a 2,00	200	100	85	487	527	569	632	670	463	13,6	2 HILTON + 2 RIÑONERAS	1,53
	Pradas 2 pl	180	100	85	466	504	550	603	639	443	13,4	2 HILTON + 2 RIÑONERAS	1,38
	Pradas 1 pl c/60	80	100	85	362	401	436	583	618	344	6,8	1 RIÑONERA + 1 CAB. FLOTANTE	0,61
	Pradas 1 pl c/80	100	100	85	372	411	446	473	501	353	7,3	1 RIÑONERA + 1 CAB. FLOTANTE	0,77
	Pradas 1 pl c/90	110	100	85	376	415	453	480	509	357	7,5	1 RIÑONERA + 1 CAB. FLOTANTE	0,85
	Pradas 1 pl c/100	120	100	85	384	422	461	489	518	365	8	1 RIÑONERA + 1 CAB. FLOTANTE	0,92
	Pradas mod. 3 Pl a 2,10 1/b	210	100	85	487	527	569	603	639	463	11,8	1 HILTON + 2 RIÑONERAS	1,61
	Pradas mod. 3 Pl a 1,90 1/b	190	100	85	466	504	550	583	618	443	11,5	1 HILTON + 2 RIÑONERAS	1,46
	Pradas mod. 2 Pl 1/b	170	100	85	441	481	527	559	593	419	11,3	1 HILTON + 1 RIÑONERA	1,31
	Pradas mod. 1 Pl a 1,10 1/b	110	100	85	380	418	453	480	509	361	8,5	1 HILTON + 1 RIÑONERA	0,85
	Pradas mod. 1 Pl a 1,00 1/b	100	100	85	372	411	447	474	502	353	8,2	1 HILTON + 1 RIÑONERA	0,77
	Pradas mod. 1 Pl a 0,90 1/b	90	100	85	368	406	440	466	494	350	8	1 HILTON + 1 RIÑONERA	0,69
	Pradas mod. 1 Pl a 1,30 1/b	130	100	85	390	430	466	494	524	371	10,2	1 HILTON + 1 RIÑONERA	1,00
	Pradas mod. 3 Pl s/b 2,00	200	100	85	466	504	550	583	618	443	10	2 RIÑONERAS	1,53
	Pradas mod. 3 Pl s/b 1,80	180	100	85	441	481	523	554	587	419	9,5	2 RIÑONERAS	1,38
	Pradas mod. 2 Pl s/b	160	100	85	419	456	500	530	562	398	9,2	2 RIÑONERAS	1,22
	Pradas mod. 1 Pl s/b	80	100	85	327	364	386	409	434	311	5,7	1 RIÑONERA	0,61
110 	Pradas mod. Rincón 1,10*1,10	110	110	85	419	456	500	530	562	398	7,2	-	0,93
100 	Pradas chaiselóngue terminal	100	200	85	466	501	550	583	618	443	11,2	1 HILTON + 1 RIÑONERA	1,53

Tarifa por puntos/rate/tarif	medidas / measurements / mesures	Series telas / Fabrics series / Série de tissus									Metroje	Nº Decorativos	Cubiçaje M³
		Largo	Fondo	Altura	G/0	G/1	G/2	G/3	G/4	T Cliente			
110 	Pradas chaiselóngue 1,10*1,75	110	175	85	459	494	540	572	606	436	9,8	2 HILTON + 1 RIÑONERA	1,48
100 	Pradas chaiselóngue 1,00*1,75	100	175	85	448	482	528	560	594	426	9,5	2 HILTON + 1 RIÑONERA	1,34
90 	Pradas haiselóngue 0,90*1,75	90	175	85	477	512	561	595	631	453	9,2	2 HILTON + 1 RIÑONERA	1,21
73 	Pradas Pouf 1,00 *0,73	100	73		229	252	275	292	310	218	3,2	-	0,30
73 	Pradas Pouf 0,90 *0,73	90	73		217	241	264	280	297	206	2,8	-	0,30
73 	Pradas Pouf 0,80 *0,73	80	73		207	229	241	255	270	197	2,5	-	0,20
60 	Pradas Pouf 0,73 *0,60	73	60		197	220	232	246	261	187	2,3	-	0,20



Pradas en Flint 20, decorativos en Flint 43 y Velvet 73  
Pradas in Flint 20, pillows in flint 43 and velvet 73 / Pradas in Flint 20, pillows in flint 43 and velvet 73

Pradas rinconera en Flint 43, decorativos en Velvet 60, Velvet 89 y Velvet 85  
Pradas canapé d'angle en flint 43, coussins deco en Velvet 60, velvet 89 et velvet 85  
Pradas corner upholstered in Flint 43, pillows in velvet 60, 89 and 85

## Características técnicas / Technical characteristics / Caractéristiques techniques

- ESTRUCTURA: CHASIS METÁLICO.
- RECUBRIMIENTO: ESPUMA DE POLIURETANO DE 1,5 CM.
- ALMOHADAS ASIENTOS: BULFLEX
- ALMOHADAS RESPALDO: FIBRA DE MICROFIBRA TACTO PLUMA.
- PATAS: METÁLICAS.
- STRUCTURE: BOIS DE PIN ET BOIS DE PARTICULES
- RECOUVREMENT: COUCHE DE MOUSSE POLYURÉTHANE DE 1,5 CM
- COUSSIN D'ASSISE: BULFLEX
- COUSSIN DE DOSSIER: FIBRE DE MICROFIBRE SENSATION PLUME
- PIÈTEMENT : MÉTALLIQUE
- STRUCTURE: PINE WOOD AND WOOD PARTICLES
- RECOVERY: LAYER OF POLYURETHANE FOAM OF 1.5 CM
- SEAT CUSHION: BULFLEX
- BACK CUSHION: FIBER OF MICROFIBER FEATHER TOUCH
- LEGS: METAL

## Opciones de patas / Leg options / Options de jambe

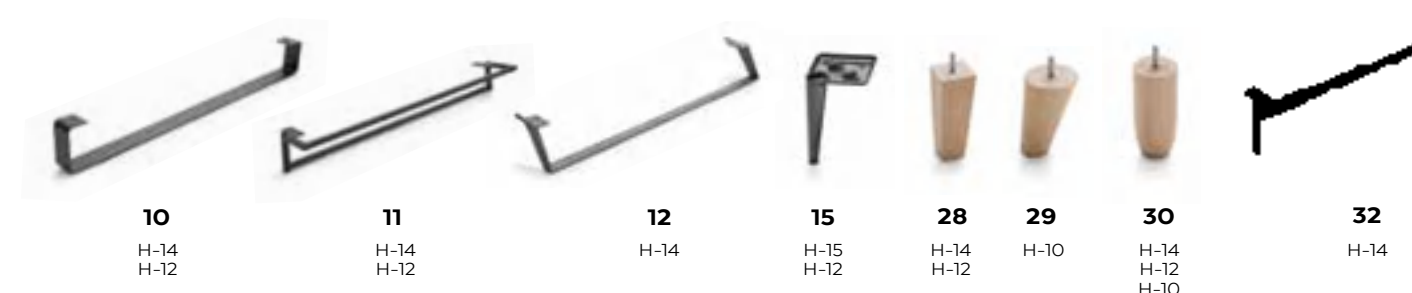

El cambio de pata puede suponer un incremento en el precio. / Le changement de piètement peut entrainer un supplément sur le prix. / Change of legs could lead to a supplement.

## Bastidor metálico

/ Metallic frame / Chassis métallique







**DVN**<sup>®</sup>  
S T A R  
La marca que mejor te sienta



**Ds**

Ds en Zafiro 2, decorativos en Ascot Pearl  
DS in zafiro 02 , pillows in Ascot pearl / DS en zafiro 02 , decos en Ascot Pearl  
Ds página izquierda en Zafiro 10, decorativos en Ascot Pearl  
DS in zafiro 10, pillows in Ascot Pearl / DS en zafiro 10 , decos en Ascot pearl

**DS**



Ds en Zafiro 5, decorativos en Ascot Pearl  
DS in zafiro 05 , pillows in Ascot pearl / DS en zafiro 05 , coussins deco en Ascot pearl











Ds en Zafiro 5, decorativos en Ascot Pearl  
DS in zafiro 05 , pillows in Ascot pearl / DS en zafiro 05 , coussins deco en Ascot pearl

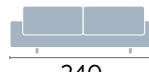
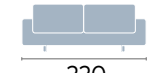
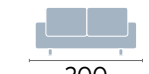





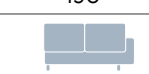
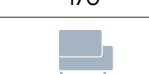

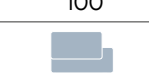
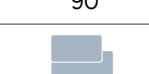
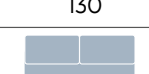
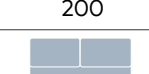
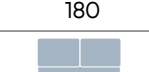
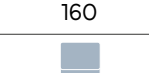
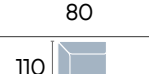

**DVN**  
S T A R  
La marca que mejor te sienta



Ds

Tarifa por puntos/rate/tarif	medidas / measurements / mesures	Series telas / Fabrics series / Série de tissus									Metroaje	Nº Decorativos	Cubicaje M <sup>3</sup>
		Largo	Fondo	Altura	G/0	G/1	G/2	G/3	G/4	T Cliente			
85 	DS 3 CABEZALES 240	240	100	85	669	708	760	806	854	600	21,2	2 HILTON + 3 RIÑONERAS	1,82
	DS 3 PL A 240	240	100	85	669	708	760	806	854	600	21,2	2 HILTON + 2 RIÑONERAS	1,82
	DS 3 PL A 220	220	100	85	632	670	716	759	805	570	20,2	2 HILTON + 2 RIÑONERAS	1,66
	DS 3 PL A 200	200	100	85	597	637	679	720	763	530	19,4	2 HILTON + 2 RIÑONERAS	1,51
	DS 2 PL A A 180	180	100	85	576	614	660	700	742	520	18,1	2 HILTON + 2 RIÑONERAS	1,36
	DS 1 PL (COJÍN 80) 96	100	100	85	424	457	489	512	537	408	11,5	1 HILTON + 1 RIÑONERA	0,76
	DS 1 PL (COJÍN 90) 110	110	100	85	428	461	495	512	544	412	12,25	1 HILTON + 1 RIÑONERA	0,84
	DS 1 PL (COJÍN 90) 120	120	100	85	434	468	504	525	551	417	13	1 HILTON + 1 RIÑONERA	0,91
	DS MOD. 3 PL 210 I/B	210	100	85	597	637	679	720	763	530	16	1 HILTON + 2 RIÑONERAS	1,59
	DS MOD. 3 PL 190 I/B	190	100	85	590	630	672	712	755	520	15,1	1 HILTON + 2 RIÑONERAS	1,44
	DS MOD. 2 PL 170 I/B	170	100	85	541	581	627	665	705	560	14,3	1 HILTON + 2 RIÑONERAS	1,29
	DS MOD. 1 PL COJÍN 100 I/B	110	100	85	430	464	495	519	544	414	11,5	1 HILTON + 2 RIÑONERA	0,84
	DS MOD 1 PL COJÍN 90 I/B	100	100	85	424	457	489	512	537	408	11	1 HILTON + 1 RIÑONERA	0,76
	DS MOD 1 PL COJÍN 80 I/B	90	100	85	420	453	483	506	530	404	10,5	1 HILTON + 1 RIÑONERA	0,69
	DS MOD 1,5 PL COJÍN 120 I/B	130	100	85	440	474	505	529	555	423	12	1 HILTON + 1 RIÑONERA	0,99
	DS MOD 3P 200 S/B	200	100	85	587	627	669	709	752	520	16	2 RIÑONERAS	1,51
	DS MOD 3P 180 S/B	180	100	85	566	606	650	689	730	510	15,2	2 RIÑONERAS	1,36
	DS MOD 2 PL 160 S/B	160	100	85	530	570	617	654	693	490	13,5	2 RIÑONERAS	1,21
	DS MOD 80 S/B	80	100	85	384	416	436	456	477	370	9	1 RIÑONERA	0,61
110 	DS RINCÓN	110	110	85	530	570	617	654	693	490	10	1 HILTON	0,92

Tarifa por puntos/rate/tarif	medidas / measurements / mesures	Series telas / Fabrics series / Série de tissus									Metroaje	Nº Decorativos	Cubicaje M <sup>3</sup>
		Largo	Fondo	Altura	G/0	G/1	G/2	G/3	G/4	T Cliente			
110 	DS CHASISELONGUE 110*175	110	175	85	555	586	629	658	688	535	12,5	2 HILTON + 1 RIÑONERA	1,46
100 	DS CHASISELONGUE 100*175	100	175	85	550	580	620	648	678	530	12	2 HILTON + 1 RIÑONERA	1,33
90 	DS CHASISELONGUE 90*175	90	175	85	540	570	610	638	667	521	11,5	2 HILTON + 1 RIÑONERA	1,19
110 	DS MOD TERMINAL 110*200	110	200	85	615	646	689	718	749	594	15	1 HILTON + 1 RIÑONERA	1,66
110 	DS MOD TERMINAL 110*175	110	175	85	565	596	639	668	699	544	14	1 HILTON + 1 RIÑONERA	1,46
73 	DS POUF 100*73	100	73	42	250	270	290	304	319	240	8,5	-	0,28
73 	DS POUF 90*73	90	73	42	240	260	280	294	309	231	8	-	0,25
73 	DS POUF 80*73	80	73	42	230	250	260	273	286	221	7,5	-	0,22
60 	DS POUF 73*60	73	60	42	222	242	252	264	277	213	6,8	-	0,16

### Características técnicas / Technical characteristics / Caractéristiques techniques

- ESTRUCTURA: BASE METÁLICA CON MUELLES ZIG-ZAG
- ESTRUCTURA BRAZOS Y RESPALDOS: MADERA DE PINO
- RECUBRIMIENTO: ESPUMA DE POLIURETANO DE 1,5 CM
- ALMOHADONES ASIENTO: BULFLEX
- ALMOHADONES RESPALDO: FIBRA DE MICROFIBRA CON TACTO DE ALGODÓN
- DESENFUNDABLE COMPLETO CON FUNDA INTERIOR
- PATAS: METÁLICAS.

- STRUCTURE : METALLIC FRAME WITH ZIGZAG SPRINGS
- ARMREST AND BACKREST STRUCTURE :PINE WOOD
- RECOVERY :LAYER OF POLYURETHANE FOAM 1.5 CM
- SEAT CUSHION: BULFLEX FOAM
- BACK CUSHION:FIBER OF MICROFIBER , COTTON SENSATION
- TAPESTRY TOTALLY REMOVABLE WITH INTERN PROTECTIVE COVER
- LEGS : METAL
- OPTION WOODEN LEGS 12-14 CM HIGH

- STRUCTURE: CHÂSSIS MÉTALLIQUE AVEC RESSORTS NOSAG
- STRUCTURE ACCOUDOIRS ET DOSSIER: BOIS DE PIN
- RECOUVREMENT: COUCHE DE MOUSSE POLYURÉTHANE 1.5 CM
- COUSSIN D'ASSISE: MOUSSE BULFLEX
- COUSSIN DE DOSSIER: FIBRE DE MICROFIBRE
- SENSATION COTON
- TAPESTRY DÉHOUSABLE AVEC HOUSSE INTÉRIEUR TOTALEMENT DÉHOUSABLE AVEC HOUSSE INTÉRIEUR
- PIÈTEMENT: MÉTALLIQUE
- OPTION PIÈTEMENT BOIS (HAUTEUR 12-14 CM DU SOL)

### Opciones de patas / Leg options / Options de jambe



28

H-14

H-12

### Bastidor metálico

/ Metallic frame / Chassis métallique



El cambio de pata puede suponer un incremento en el precio. / Le changement de piètement peut entraîner un supplément sur le prix. / Change of legs could lead to a supplement.

**DVNI**<sup>®</sup>  
S T A R

La marca que mejor te sienta





**DVN**<sup>®</sup>  
S T A R  
La marca que mejor te sienta



# California

California en Rado 6  
California in rado 06 / California en rado 06  
California pág. izquierda en Rado 10  
California in rado 10 / California en rado 10



California en Rado 15, decorativos en Rado 16  
California in rado 15 , decorative pillows in rado16 / California en rado 15, coussins deco en rado 16.

## California



California en Rado 12, decorativos en Rado 10  
California in rado 12 , decorative pillows in rado 10 / California en rado 12 , coussins deco en rado 10











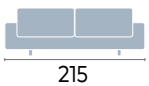
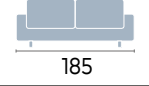

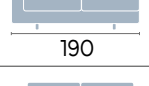
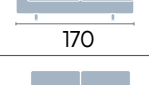
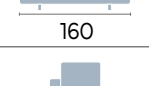
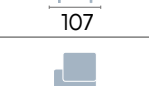
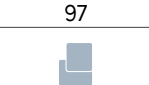
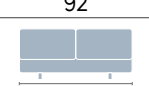

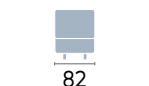
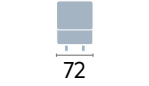
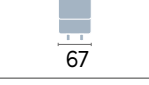

## California

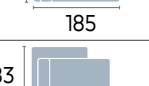
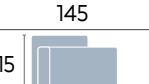

# California

Tarifa por puntos/rate/tarif	medidas / measurements / mesures			Series telas / Fabrics series / Série de tissus						Series piel / Leather series / Série cuir				Metroje	Nº Decorativos	Cubicaje M <sup>3</sup>	
	Largo	Fondo	Altura	G/0	G/1	G/2	G/3	G/4	T Cliente	Piel 1	Piel 2	Piel 3	Piel 4				
96 	California 3 pl	215	100	96	376	406	450	477	506	350	710	746	821	903	12	-	1,83
185 	California 2 pl	185	100	96	349	379	415	440	466	283	660	693	762	838	11	-	1,58
117 	California 1 pl	117	100	96	250	280	310	329	349	247	510	536	590	649	8,2	-	1,00
190 	California mod. 3 Pl 1/b 1,90 c/82	190	100	96	360	390	428	454	481	335	660	693	762	838	10,7	-	1,62
170 	California mod. 3 Pl 1/b 1,70 c/72	170	100	96	349	378	415	440	466	325	640	672	739	813	9,8	-	1,45
160 	California mod. 2 Pl 1/b	160	100	96	334	364	397	421	446	268	623	654	719	791	9,3	-	1,37
107 	California mod. 1 Pl 1/b c/82	107	100	96	249	279	309	328	348	232	490	515	567	624	7	-	0,92
97 	California mod. 1 Pl 1/b c/72	97	100	96	245	275	305	323	342	228	486	511	562	618	6	-	0,83
92 	California mod. 1 Pl 1/b c/67	92	100	96	238	266	295	313	332	221	485	509	560	616	6	-	0,78
165 	California mod. 3 Pl s/b 1,65	165	100	96	342	371	406	430	456	318	630	662	728	801	10,4	-	1,41
135 	California mod. 2 Pl s/b 1,35	135	100	96	319	348	379	402	426	255	592	621	683	751	9,8	-	1,16
82 	California mod. 1 Pl s/b c/82	82	100	96	238	266	295	313	332	221	485	509	560	616	5,1	-	0,70
72 	California mod. 1 Pl s/b c/72	72	100	96	234	262	291	308	326	217	481	505	556	612	5	-	0,61
67 	California mod. 1 Pl sb/ c/67	67	100	96	226	253	280	297	315	210	455	478	526	579	5	-	0,57
110 	California mod. Rincón	110	110	96	274	303	334	354	375	255	592	621	683	751	7,3	-	1,03
103 	California chaiselón 1,03*1,85	103	185	96	325	335	362	384	407	302	615	646	711	782	8,9	2 DECO 50*50	1,63
103 	California chaiselón 1,03*1,45	103	145	96	309	320	345	366	388	287	585	614	675	743	7,1	1 DECO 50*50	1,27
83 	California chaiselón 0,83*1,85	83	185	96	309	320	345	366	388	287	585	614	675	743	8,5	2 DECO 50*50	2,68
83 	California chaiselón 0,83*1,45	83	145	96	294	306	331	351	372	273	557	584	642	706	7,1	1 DECO 50*50	1,03
115 	California chaiselón mv1 1,15*1,75	115	175	96	340	350	375	398	422	316	635	667	734	807	9,5	2 DECO 50*50	1,72
105 	California chaiselón mv1 1,05*1,75	105	175	96	330	340	364	386	409	307	610	641	705	776	8,9	2 DECO 50*50	1,57

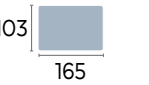
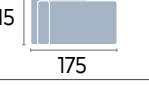
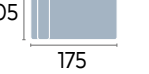
Tarifa por puntos/rate/tarif	medidas / measurements / mesures			Series telas / Fabrics series / Série de tissus						Series piel / Leather series / Série cuir				Metroje	Nº Decorativos	Cubicaje M <sup>3</sup>	
	Largo	Fondo	Altura	G/0	G/1	G/2	G/3	G/4	T Cliente	Piel 1	Piel 2	Piel 3	Piel 4				
103 	California tumbona	103	165	96	309	320	345	366	388	287	585	614	675	743	8,7	2 DECO 50*50	1,45
115 	California chaiselón brazo arcón	115	175	96	350	360	385	408	432	326	645	677	745	820	8,4	2 DECO 50*50	1,72
105 	California chaiselón brazo arcón	105	175	96	340	350	375	398	422	307	610	641	705	776	8,2	2 DECO 50*50	1,57

## Características técnicas / Technical characteristics / Caractéristiques techniques

- ESTRUCTURA: MADERA PINO
- RECUBRIMIENTO: ESPUMA DE PULIERUTANO 1,5 CM
- ESTRUCTURA BRAZOS Y RESPALDOS: MADERA PINO
- ALMOHADAS ASIENTOS: GOMA 30 KG. CON MUELLES
- ALMOHADAS RESPALDO: CABEZALES GOMA Y RIÑONERAS FIBRA SILICONADA "OPTIFIBRE"
- COJINES ASIENTO EXTRAÍBLE. DESLIZANTE METÁLICO
- RESPALDOS: RECLINABLES, CABEZAL METÁLICO
- PATAS: METÁLICAS
- ESTE MODELO, SIEMPRE QUE VAYA TAPIZADO EN PIEL, NO INCLUIRÁ DECORATIVOS DE SERIE EN NINGUNA DE SUS MODULACIONES.
- SE PUEDEN REDUCIR LOS BRAZOS DEL MODELO EN 10 CM SIN INCREMENTO EN LA TARIFA, A EXCEPCIÓN DE LOS BRAZOS DE LOS DIFERENTES CHAISLONGUES Y TUMBONA DEL MISMO QUE NO ADMITIRÁN REDUCCIÓN.
- STRUCTURE: PINE WOOD
- RECOVERY: LAYER OF POLYURETHANE FOAM 1.5 CM
- STRUCTURE ARMREST AND BACKREST: PINE WOOD
- SEAT CUSHION: HR FOAM 30 KG OVER POCKET SPRINGS
- BACK CUSHION: HEADREST IN FOAM AND LOWER BACK CUSHION IN SILICONED FIBRE
- EXTENSIBLE SLIDING SEAT ON METAL SLIDES
- ADJUSTABLE HEADREST
- LEGS: METALLIC
- THERE IS NO DECORATIVE PILLOW INCLUDED IN THIS MODEL WHEN MADE IN LEATHER.
- THE WIDTH OF ARMREST CAN BE 10 CM LESS EXCPT OVER CHAISLONGS AND TUMBONAS.
- STRUCTURE BOIS DE PIN
- RECOUVREMENT COUCHE DE MOUSSE POLYURÉTHANE DE 1.5 CM
- STRUCTURE ACCOUDOIRS ET DOSSIER BOIS DE PIN
- COUSSIN D'ASSISE MOUSSE HR 30 KG POSÉE SUR RESSORTS ENSACHÉS
- COUSSINS DE RESPALDOS TÊTIÈRE EN MOUSSE CALE-REINS FIBRE
- SILICONE "OPTIFIBRE"
- COUSSIN D'ASSISE EXTENSIBLE SUR GLISSIÈRE MÉTALLIQUE
- DOSSIER AJUSTABLE
- PIÈTEMENT MÉTALLIQUE
- PAS DE DECOS INCLUS SUR CE MODELE EN CUIR
- LA LARGEUR DES ACCOUDOIRS DE CE MODELE PEUT ETRE REDUITE DE 10 CM SANS SUPPLEMENT EXCEPTE SUR LES CHAISLONGUES ET TUMBONAS



California en Rado 12, decorativos en Rado 10 / California in rado 12, decorative pillows in rado 10 / California en rado 12, coussins deco en rado 10  
California en Rado 3, decorativos en Rado 10  
California in rado 03, pillows in rado 10 / California en rado 03, coussins deco en rado 10

## Opciones de patas / Leg options / Options de jambe



22 H-8

27 H-8

El cambio de pata puede suponer un incremento en el precio. / Le changement de piètement peut entraîner un supplément sur le prix. / Change of legs could lead to a supplement.



**DVN**<sup>®</sup>  
S T A R  
La marca que mejor te sienta



# Room

Room en Hypnos 205  
Room in hypnos 205 / Room en hypnos 205  
Room pág. izquierda en Hypnos 28  
Room in hypnos 28 / Room en hypnos 28



## Room











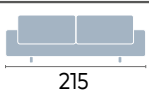
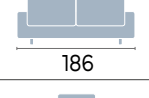
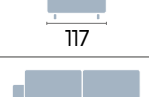
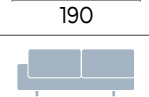
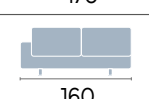
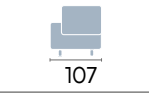

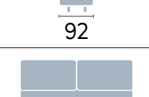
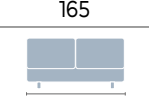
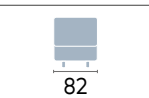
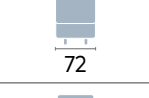
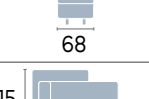
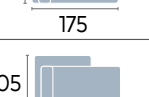
## Room

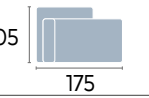
Room en Hypnos 28  
Room in hypnos 28 / Room en hypnos 28

# Room

Tarifa por puntos/rate/tarif	medidas / measurements / mesures	Series telas / Fabrics series / Série de tissus									Series piel / Leather series / Série cuir				Metroaje	Nº Decorativos	Cubicaje M <sup>3</sup>
		Largo	Fondo	Altura	G/0	G/1	G/2	G/3	G/4	T Cliente	Piel 1	Piel 2	Piel 3	Piel 4			
112 	Room 3 pl a 2,15	215	95	112	395	426	473	502	552	368	746	783	862	948	11,8	-	2,06
	Room 2 pl	186	95	112	366	395	436	462	490	297	693	728	800	880	11	-	1,78
	Room 1 pl	117	95	112	263	294	326	346	367	259	536	563	619	681	8,2	-	1,12
	Room mod. 3 Pl 1/b	190	95	112	378	410	449	476	505	352	693	728	800	880	10,6	-	1,82
	Room mod. 3 Pl a 1,70 1/b	170	95	112	366	397	436	462	490	341	672	706	776	854	10	-	1,63
	Room mod 2 pl 1/br	160	95	112	351	382	417	442	469	281	654	687	755	831	9,5	-	1,53
	Room mod. 1 Pl c/82 1/b	107	95	112	261	293	324	343	364	244	515	541	595	655	7	-	1,03
	Room mod. 1 Pl c72 1/b	97	95	112	257	289	320	339	359	239	510	537	590	649	6,3	-	0,93
	Room mod. 1 Pl 1/b	92	95	112	250	279	310	329	349	232	509	534	588	647	6,3	-	0,88
	Room mod. 3 Pl s/b	165	95	112	359	390	426	452	479	334	662	695	765	842	9	-	1,58
	Room mod. 2 Pl s/b	135	95	112	335	365	398	422	447	268	622	652	717	789	8,2	-	1,30
	Room mod. 1 Pl c/82 s/b	82	95	112	250	279	310	329	349	232	509	534	588	647	6	-	0,78
	Room mod. 1 Pl c/72 s/b	72	95	112	246	276	306	324	343	228	505	530	583	641	5,6	-	7,20
	Room mod. 1 Pl s/b	68	95	112	237	266	294	312	331	221	478	502	552	607	4,5	-	0,65
115 	Room chaiselóngue m.V1 1,15 *1,75	115	175	112	357	368	394	418	443	332	667	700	770	847	8,7	2 DECO 50*50	2,03
105 	Room chaiselóngue m.V1 1,05 *1,75	105	175	112	347	357	382	405	429	322	641	673	740	814	8,7	2 DECO 50*50	1,85
115 	Room Chaiselongue brazo arcón 1,15 * 1,75	115	175	112	368	378	404	428	454	342	677	711	782	860	10	2 DECO 50*50	2,03
105 	Room Chaiselongue brazo arcón 1,05 * 1,75	105	175	112	360	370	396	420	445	336	651	684	752	827	9,8	2 DECO 50*50	1,85
105	Room mod. Rincón	105	105	112	288	318	351	372	394	268	622	652	717	789	7	-	1,11



Room en Hypnos 615  
Room in hypnos 615 / Room en hypnos 615

## Características técnicas / Technical characteristics / Caractéristiques techniques

- ESTRUCTURA: MADERA DE PINO
  - RECUBRIMIENTO: ESPUMA DE POLIURETANO 33 KG
  - ALMOHADAS ASIENTOS: MUELLE ENSACADO
  - ALMOHADAS RESPALDO: FIBRA SILICONADA "OPTIFIBRE"
  - COJINES ASIENTO: EXTRAIBLE. DESLIZANTE METÁLICO
  - PATAS: METÁLICAS
  - ESTE MODELO, SIEMPRE QUE VAYA TAPIZADO EN PIEL, NO INCLUIRÁ DECORATIVOS DE SERIE EN NINGUNA DE SUS MODULACIONES.
  - SE PUEDEN REDUCIR LOS BRAZOS DEL MODELO EN 5 CM SIN INCREMENTO EN LA TARIFA, A EXCEPCIÓN DE LOS BRAZOS DE LOS DIFERENTES CHAISÉLONGUES QUE NO ADMITIRÁN REDUCCIÓN.
- STRUCTURE PINE WOOD
  - RECOVERY: POLYURETHANE FOAM 33 KG
  - SEAT CUSHION SPRNG POCKETS
  - BACKREST CUSHION SILICONED FIBER "OPTIFIBER"
  - METALLIC SLIDING SEAT
  - LEGS: METAL
  - THERE IS NO PILLOW INCLUDED IN THIS MODEL WHEN MADE IN LEATHER.
  - ARMREST CAN BE MADE 10 CM LESS WIDE OVER THIS MODELE EXCEPT ON CHAISÉLONGS.
- STRUCTURE BOIS DE PIN
  - RECOUVREMENT: MOUSSE DE POLYURÉTHANE 33 KG
  - COUSSINS D'ASSISE RESSORTS ENSACHETS
  - COUSSIN DE DOSSIER FIBRE SILICONÉ OPTIFIBRE
  - ASSISE SUR GLISSIÈRE MÉTALLIQUE
  - PIÈTEMENT MÉTALLIQUE
  - CE MODEL EN CUIR N'INCLUT PAS DE COUSSINS DECO
  - LES ACCPOUDOIRS DE CE MODELE PEUVENT SE FABRIQUER AVEC 10 CM MOINS LARGES A L'EXCEPTION DES CHAISÉLONGUES

## Opciones de patas / Leg options / Options de jambe



El cambio de pata puede suponer un incremento en el precio. / Le changement de piètement peut entraîner un supplément sur le prix. / Change of legs could lead to a supplement.



**DVN**<sup>®</sup>  
S T A R  
La marca que mejor te sienta



# Andrea

Andrea en Zafiro 17  
Andrea in Zafiro 17 / Andrea en Zafiro17  
Andrea pág. izquierda en Zafiro 20  
Andrea in zafiro 20 / Andrea en zafiro 20



Andrea en Zafiro 4  
Andrea in zafiro 04 / Andrea en zafiro 04  
Andrea abajo en Zafiro 18  
Andrea en zafiro 18 / Andrea in zafiro 18



Andrea en Zafiro 23  
Andrea in zafiro 23 / Andrea en zafiro 23



# Andrea











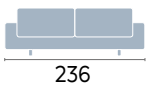
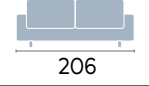

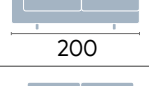
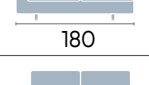
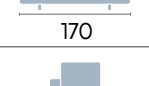
Andrea en Zafiro 4  
Andrea in zafiro 04 / Andrea en zafiro 04

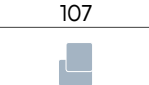

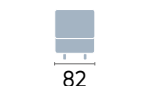
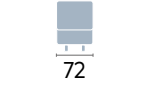
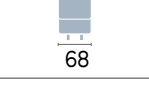
Andrea

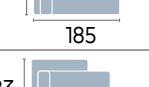
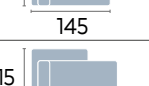
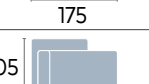
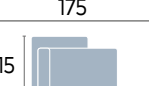
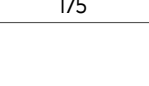

Tarifa por puntos/rate/tarif	medidas / measurements / mesures	Series telas / Fabrics series / Série de tissus								Series piel / Leather series / Série cuir				Metroje	Nº Decorativos	Cubicaje M <sup>3</sup>	
		Largo	Fondo	Altura	G/0	G/1	G/2	G/3	G/4	T Cliente	Piel 1	Piel 2	Piel 3				Piel 4
96 	Andrea 3 pl a 2,36	236	91	96	431	441	485	514	545	385	745	781	859	945	13,2	-	1,28
206 	Andrea 2 pl	206	91	96	384	414	450	477	506	318	695	728	801	881	11,5	-	1,12
140 	Andrea 1 pl	140	91	96	285	315	345	366	388	282	545	571	628	691	8	-	0,76
200 	Andrea mod. 3 Pl1/b	200	91	96	380	410	448	475	504	355	680	713	784	862	11	-	1,09
180 	Andrea mod. 3 Pl1/b 1,80	180	91	96	369	398	435	461	489	345	660	692	761	837	10,4	-	0,97
170 	Andrea mod. 2 Pl1/b	170	91	96	354	384	417	442	469	288	643	674	741	815	9,7	-	0,92
117 	Andrea mod. 1 Pl 1/b c/82	117	91	96	269	299	329	349	370	252	510	535	589	648	7,2	-	0,63
107 	Andrea mod. 1 Pl 1/b c/72	107	91	96	265	295	325	345	366	248	506	531	584	642	6,5	-	0,58
103 	Andrea mod. 1 Pl 1/b	103	91	96	258	286	315	334	354	241	505	519	571	628	5,9	-	0,56
165 	Andrea mod. 3 Pl s/b	165	91	96	347	376	411	436	462	323	635	667	734	807	9	-	0,89
135 	Andrea mod. 2 Pl s/b	135	91	96	324	353	384	407	431	260	597	626	689	758	7,5	-	0,73
82 	Andrea mod. 1 Pl s/b c/82	82	91	96	243	271	300	318	337	226	490	514	565	622	5,2	-	0,45
72 	Andrea mod. 1 Pl s/b c/72	72	91	96	239	267	296	310	329	222	486	510	550	605	5	-	0,39
68 	Andrea mod. 1 Pl s/b	68	91	96	231	258	285	302	320	215	460	483	531	584	4,8	-	0,37
103 	Andrea chaiselón 1,03 x 1,85	103	185	96	330	340	367	389	412	307	620	651	716	788	7,8	2 DECO 50*50	1,13
105 	Andrea chaiselón 1,03 x 1,45	105	145	96	314	325	350	371	393	292	590	619	681	749	6,7	1 DECO 50*50	0,91
83 	Andrea chaiselón 0,83 x 1,85	83	185	96	314	325	350	371	393	292	590	619	681	749	7,7	1 DECO 50*50	0,91
83 	Andrea chaiselón 0,83 x 1,45	83	145	96	299	311	336	356	377	278	562	589	648	713	6,2	1 DECO 50*50	0,72
115 	Andrea chaiselón mv1 1,15 x 1,75	115	175	96	345	355	380	403	427	321	640	672	739	813	9,7	1 DECO 50*50	1,20
105 	Andrea chaiselón mv1 1,05 x 1,75	105	175	96	335	345	369	391	414	312	615	646	711	782	9,3	2 DECO 50*50	1,09
115 	Andrea chaiselón brazo arcón 1,15 x 1,75	115	175	96	355	365	390	413	438	331	655	687	756	832	10,4	2 DECO 50*50	1,20

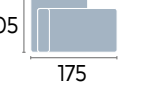
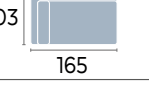
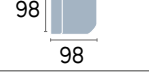
Tarifa por puntos/rate/tarif	medidas / measurements / mesures	Series telas / Fabrics series / Série de tissus								Series piel / Leather series / Série cuir				Metroje	Nº Decorativos	Cubicaje M <sup>3</sup>	
		Largo	Fondo	Altura	G/0	G/1	G/2	G/3	G/4	T Cliente	Piel 1	Piel 2	Piel 3				Piel 4
105 	Andrea chaiselón largo brazo arcón 1,05 x 1,75	105	175	96	345	355	380	403	428	321	625	657	726	799	9,6	2 DECO 50*50	1,09
103 	Andrea tumbona	103	165	96	304	325	350	371	393	292	590	619	681	749	8,8	2 DECO 50*50	1,01
98 	Andrea mod. Rincón	98	98	96	279	308	339	359	381	260	597	626	689	758	7	-	0,57



Andrea en Zafiro 18  
Andrea en zafiro 18 / Andrea in zafiro 18

## Características técnicas / Technical characteristics / Caractéristiques techniques

- ESTRUCTURA: MADERA DE PINO
- RECUBRIMIENTO: ESPUMA POLIURETANO DE 1,5 CMS
- ALMOHADAS ASIENTO: ASIENTO HR 30 KG. PARTE SUPERIOR DOBLE COJIN 60% PICADO VISCOLASTICA Y 40% PICADO FIBRA
- ALMOHADAS RESPALDO: FIBRA ALTA RESISTENCIA "OPTIFIBRE"
- COJINES ASIENTO EXTRAIBLES, DESLIZANTES METALICOS
- RESPALDOS RECLINABLES. CABEZAL METÁLICO
- BRAZOS EXTENSIBLES, A EXCEPCIÓN DE LA CHAISÉLONGUE O TUMBONA.
- PATAS DELANTERAS METÁLICAS. TRASERAS PVC (PATAS PLÁSTICO)
- ESTE MODELO, SIEMPRE QUE VAYA TAPIZADO EN PIEL, NO INCLUIRÁ DECORATIVOS DE SERIE EN NINGUNA DE SUS MODULACIONES.
- NO SE ADMITE REDUCCION DE BRAZOS EN NINGUNO DE LOS MODULOS
- STRUCTURE PINE WOOD
- RECOVERY: LAYER OF POLYURETHANE 1.50 CM
- SEAT CUSHION: HR FOAM 30 KG STADDLED WITH A DOUBLE LAYER OF 60% VISCO AND 40 % CHOPPED FIBER
- BACK CUSHION HIGH RESISTANCE FIBER OPTIFIBER
- EXTENSIBLE SEAT ON METAL SLIDE
- ADJUSTABLE HEADREST
- SLIDING ARMREST EXCEPT ON CHAISÉLONGUE
- LEGS: FRONT SIDE METAL LEGS AND BACK SIDE PLASTIC (PVC)
- THERE IS NO PILLOW INCLUDED IN THIS MODELE WHEN MADE IN LEATHER.
- THERE IS NO POSSIBILITY TO REDUCE THE WITH OF ARMREST IN THIS MODEL
- STRUCTURE BOIS DE PIN
- RECOUVREMENT: COUCHE DE POLYURÉTHANE 1.5 CM
- COUSSIN D'ASSISE: MOUSSE HR 30 KG GARNI D'UNE DOUBLE COUCHE DE 60% VISCOELASTIC 40% FIBRE HACHÉ
- COUSSIN DE DOSSIER FIBRE HAUTE RÉSIDENCE OPTIFIBRE
- ASSISE EXTENSIBLE SUR GLISSIÈRE MÉTALLIQUE
- TÊTIÈRE MÉTALLIQUE AJUSTABLE
- ACCOUDOIR SUR GLISSIÈRE EXCEPTÉ SUR LA CHAISE LONGUE
- PIÈTEMENT: DEVANT MÉTALLIQUE, ARRIÈRE PVC (PLASTIC)
- CE MODELE N'INCLUT PAS DE DECOS LORSQU'IL EST FABRIQUÉ EN CUIR).
- LES ACCOUDOIRS DE CE MODELE NE PEUVENT EN AUCUN CAS SE REDUIRE

## Opciones de patas / Leg options / Options de jambe



El cambio de pata puede suponer un incremento en el precio. / Le changement de piètement peut entrainer un supplément sur le prix. / Change of legs could lead to a supplement.



**DVN**<sup>®</sup>  
S T A R  
La marca que mejor te sienta



# Sandy

Sandy en Diva Cemento  
Sandy en diva cemento / Sandy in diva cemento  
Sandy pág. izquierda en Diva Jade  
Sandy in diva jade / Sandy en diva jade





Sandy en Diva Índigo  
*Sandy in diva indigo / Sandy en diva indigo*

## Sandy

Una de las mayores ventajas estéticas y funcionales del modelo Sandy de DVN STAR es la movilidad de uno de sus brazos así como de los respaldos para la cabeza, lo que nos permite regularlos a placer.

The most esthetic and functional advantage of the model Sandy from DVN STAR is the mobility of one of its armrests and the headboard that can be regulated as one wants.

L'un des plus grands avantages esthétiques et fonctionnels du modèle Sandy de DVN STAR est la mobilité de l'un de ses bras ainsi que des oreillers, ce qui nous permet de les positionner à notre goût.



Sandy en Diva Naranja  
*Sandy in diva naranja (orange) / Sandy en diva naranja (orange)*

Sandy en Diva Palo de Rosa  
*Sandy in diva palo de rosa / Sandy en diva palo de rosa*











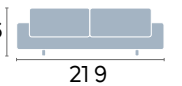
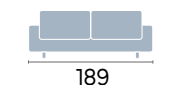

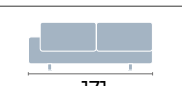
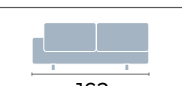

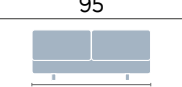
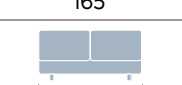

# Sandy

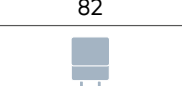

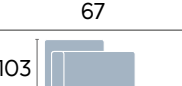
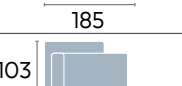
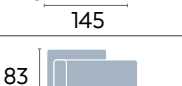
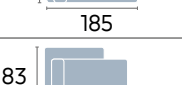
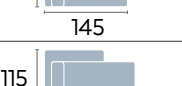
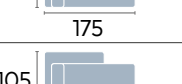
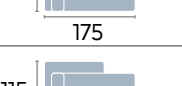
Sandy en Diva Palo de Rosa  
*Sandy in diva palo de rosa / Sandy en diva palo de rosa*

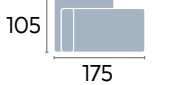
# Sandy

Tarifa por puntos/rate/tarif	medidas / measurements / mesures	Series telas / Fabrics series / Série de tissus									Metraje	Nº Decorativos	Cubiçaje M <sup>3</sup>
		Largo	Fondo	Altura	G/0	G/1	G/2	G/3	G/4	T Cliente			
96 	Sandy 3 pl a 2,19	219	90	96	366	396	440	466	494	340	11,8	-	1,17
	Sandy 2 pl	189	90	96	339	369	405	429	455	273	10,7	-	1,01
	Sandy 1 pl	122	90	96	250	280	310	329	349	233	7,2	-	0,65
	Sandy mod. 3 Pl 1/b	191	90	96	350	380	413	438	464	326	10,8	-	1,02
	Sandy mod. 3 Pl a 1,71/b	171	90	96	343	372	405	429	455	319	10,8	-	0,92
	Sandy mod. 2 Pl 1/b	162	90	96	330	359	394	418	443	265	9	-	0,87
	Sandy mod. 1 Pl c/80 1/b	109	90	96	248	277	305	323	342	230	7	-	0,58
	Sandy mod. 1 Pl c/72 1/b	99	90	96	244	273	301	319	338	226	6,5	-	0,53
	Sandy mod. 1 Pl 1/b	95	90	96	235	264	292	310	329	219	6	-	0,51
	Sandy mod. 3 Pl s/b	165	90	96	336	365	396	420	445	312	9,25	-	0,89
	Sandy mod. 2 Pl s/b	135	90	96	321	350	384	407	431	257	8,4	-	0,73
	Sandy mod. 1 Pl c/80 s/b	82	90	96	240	269	297	315	334	223	5,3	-	0,44
	Sandy mod. 1 Pl c/72 s/b	72	90	96	236	265	293	311	330	219	5,1	-	0,38
	Sandy mod. 1 Pl s/b	67	90	96	235	264	292	310	329	217	5,1	-	0,36
	Sandy chaiselón 1,03 x 1,85	103	185	96	310	320	346	367	389	288	9	2 DECO 50*50	1,13
	Sandy chaiselón 1,03 x 1,45	103	145	96	300	310	336	356	377	279	7	1 DECO 50*50	0,89
	Sandy chaiselón 0,83 x 1,85	83	185	96	300	310	336	356	377	279	9	2 DECO 50*50	0,91
	Sandy chaiselón 0,83 x 1,45	83	145	96	290	300	326	346	367	270	7	1 DECO 50*50	0,72
	Sandy chaiselón 1,15 x 1,75 mvl	115	175	96	335	345	362	384	407	302	10	2 DECO 50*50	1,20
	Sandy chaiselón 1,05 x 1,75 mvl	105	175	96	325	335	352	373	395	293	8	2 DECO 50*50	1,09
	Sandy chaiselón brazo arcon 1,15 x 1,75	115	175	96	350	360	385	408	432	326	10	2 DECO 50*50	1,20

Tarifa por puntos/rate/tarif	medidas / measurements / mesures	Series telas / Fabrics series / Série de tissus									Metraje	Nº Decorativos	Cubiçaje M <sup>3</sup>
		Largo	Fondo	Altura	G/0	G/1	G/2	G/3	G/4	T Cliente			
105 	Sandy chaiselón brazo arcon 1,05 x 1,75	105	175	96	340	350	375	398	422	316	10	2 DECO 50*50	1,09
93 	Sandy chaiselón terminal 0,93 x 1,98	93	198	96	360	390	428	454	481	335	11	-	1,10
103 	Sandy tumbona	103	165	96	305	315	341	361	383	284	8	2 DECO 50*50	1,01
105 	Sandy mod. Rincón	105	105	96	278	305	339	359	381	257	7	-	0,66



1. Sandy en Diva Índigo  
Sandy in diva indigo / Sandy en diva indigo  
2. Sandy en Diva Naranja  
Sandy in diva naranja (orange) / Sandy en diva naranja (orange)

## Características técnicas / Technical characteristics / Caractéristiques techniques

- ESTRUCTURA: MADERA DE PINO
- RECUBRIMIENTO: ESPUMA POLIURETANO DE 1,5 CM.
- ALMOHADAS ASIENTOS: MUELLE ENSACADO Y POLIURETANO 33 KG.
- ALMOHADAS RESPALDO: FIBRA SILICONDA "OPTIFIBRE"
- COJINES DE ASIENTO: EXTRAIBLE. DESLIZANTE METÁLICO
- RESPALDOS: RECLINABLE. CABEZAL METÁLICO
- PATAS: MADERA DE PINO
- SE PUEDEN REDUCIR LOS BRAZOS DEL MODELO EN 10 CM SIN INCREMENTO EN LA TARIFA, A EXCEPCIÓN DE LOS BRAZOS DE LOS DIFERENTES CHAISÉLONGUES Y TUMBONAS DEL MISMO QUE NO ADMITIRÁN REDUCCIÓN
- STRUCTURE PINE WOOD
- RECOVERY: LAYER OF POLYURETHANE 1.5 CM
- SEAT CUSHION: POCKET SPRINGS AND POLYURETHANE FOAM OF 33 KG.
- BACKREST CUSHION: SILICONED FIBER "OPTIFIBRE"
- METALLIC SLIDING SEAT
- ADJUSTABLE METALLIC HEADREST
- LEGS: PINE WOOD
- ARMREST OF THIS MODEL CAN BE MADE WITH 10 CM LESS WIDE EXCEPT OVER CHAISÉLONGUES AND TUMBONAS
- STRUCTURE BOIS DE PIN
- RECOUVREMENT COUCHE DE MOUSSE POLYURÉTHANE 1.5 CM
- COUSSIN D'ASSISE: RESSORTS EN SACHET ET MOUSSE POLYURÉTHANE 33 KG.
- COUSSIN DE DOSSIER FIBRE SILICONÉ "OPTIFIBRE"
- ASSISE SUR GLISSIÈRE MÉTALLIQUE
- TÊTIÈRE MÉTALLIQUE RÉGULABLE
- PIÉTEMENT: BOIS DE PIN
- LES ACCOUDOIRS DE CE MODELE PEUVENT ETRE REDUITS DE 10 CM EXCEPTE SUR LES CHAISÉLONGUES ET TUMBONAS

## Opciones de patas / Leg options / Options de jambe



El cambio de pata puede suponer un incremento en el precio. / Le changement de piètement peut entraîner un supplément sur le prix. / Change of legs could lead to a supplement.



**DVN**<sup>®</sup>  
S T A R  
La marca que mejor te sienta



# Bed

Bed en Diva Oro  
Bed in Diva oro(gold) / Bed en Diva oro  
Bed pág. izquierda en Diva Crudo  
Bed opposit page in Diva crudo / Bed page gauche en Diva crudo



Bed en Diva Jade  
Bed in diva jade / Bed en diva jade











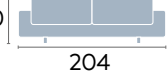
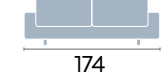

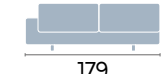

Bed arriba en Diva Acero  
Bed in diva acero / Bed en diva acero  
Bed abajo en Diva Palo de Rosa  
Bed in diva palo de rosa / Bed en diva palo de rosa

## Bed

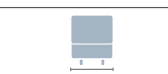

# Bed

Tarifa por puntos/rate/tarif	medidas / measurements / mesures	Series telos / Fabrics series / Série de tissus									Metroje	N° Decorativos	Cubiçaje M³
		Largo	Fondo	Altura	G/0	G/1	G/2	G/3	G/4	T Cliente			
100  204	Bed 3pl a 2,04	204	102	100	432	458	491	520	552	410	12,6	2 DECO 50*50	1,85
 174	Bed 2 pl	174	102	100	392	416	446	473	501	372	11,5	2 DECO 50*50	1,58
 112	Bed 1 pl	112	102	100	307	326	349	370	392	292	8,5	-	1,01
 179	Bed mod 3 pl 1/br	179	102	100	416	441	472	500	530	395	10,5	1 DECO 50*50	1,63
 149	Bed mod 2 pl 1/br	149	102	100	370	393	421	446	473	352	9,3	1 DECO 50*50	1,35
 102	Bed mod 1 pl c/76 1/br	102	102	100	307	326	349	370	392	292	6,8	1 DECO 50*50	0,93
 87	Bed mod 1 pl c/62 1/br	87	102	100	297	316	339	359	381	282	6,2	-	0,79
 154	Bed mod 3 pl s/br	154	102	100	396	420	450	477	506	376	9,25	-	1,40
 124	Bed mod 2 pl s/br	124	102	100	350	371	397	421	446	333	8,4	-	1,12
 76	Bed mod 1 pl c/76 s/br	76	102	100	287	305	327	347	367	273	6	-	0,69
 62	Bed mod 1 pl c/62 s/br	62	102	100	277	295	317	336	356	263	4,8	-	0,56
102  145	Bed chaiselón 1,02 x 1,45	102	145	100	330	350	375	398	421	314	8,2	1 DECO 50*50	1,32
102  175	Bed chaiselón 1,02 x 1,75	102	175	100	376	399	427	453	480	357	9	2 DECO 50*50	1,59
100  200	Bed chaiselónque terminal 1,00x 2,00	100	200	100	401	431	475	504	535	381	11,5	-	1,78
110  110	Bed mod rincón	110	110	100	376	399	427	453	480	357	6,7	-	1,08



Bed en Diva Oro  
Bed in Diva oro(gold) / Bed en Diva oro

## Características técnicas / Technical characteristics / Caractéristiques techniques

- ESTRUCTURA: MADERA DE PINO.
  - RECURRIMIENTO: GOMA.
  - ALMOHADAS ASIENTOS: DESLIZANTE 45 CM.
  - ALMOHADAS RESPALDO: RECLINABLE.
  - COJINES ASIENTO: GOMA 35 KG CON BULFLEX.
  - RESPALDO: FIBRA.
  - PATAS METÁLICAS.
  - SE PUEDEN REDUCIR LOS BRAZOS DEL MODELO EN 5 CM SIN INCREMENTO, A EXCEPCIÓN DE LOS DIFERENTES BRAZOS DE CHAISLONGUES QUE NO ADMITIRÁN REDUCCIÓN
- STRUCTURE: PINE WOOD
  - RECOVERY: LAYER OF POLYURETHANE FOAM 1.5 CM
  - SLIDING SEAT CUSHION( 45 CM ): FOAM 35 KG + A LAYER OF MICROFIBRE ON TOP
  - BACK CUSHION: LOWER PART (KIDNEY CUSHION)
  - BULFLEX AND HEADREST IN FOAM
  - ADJUSTABLE HEADREST
  - LEGS: METALLIC
  - ARMREST OVER THIS MODEL CAN BE REDUCED OF 05 CM EXCEPT OVER CHAISLONGUES AND TUMBONAS
- STRUCTURE: BOIS DE PIN
  - RECOUVREMENT: COUCHE DE MOUSSE POLYURÉTHANE 1.5 CM
  - COUSSIN D'ASSISE: MOUSSE 35 KG SUPLOMBÉE D'UNE COUCHE DE MICROFIBRE SUR GLISSIERE METALLIQUE
  - COUSSIN DE DOSSIER: CALE-REIN EN BULFLEX ET TÊTIÈRE EN MOUSSE
  - TÊTIÈRE AJUSTABLE
  - PIÈTEMENT: MÉTALLIQUE
  - LES ACCOUDOIRS DE CE MODELE PEUVENT ETRE REDUIT DE 05 CM MAX MAIS PAS SUR LES CHAISLONGUES OU TUMBONA



Bed en Diva Palo de Rosa  
Bed in diva palo de rosa / Bed en diva palo de rosa



**DVN**<sup>®</sup>  
S T A R  
La marca que mejor te sienta



# Creta

Creta en Thalís 15  
Creta en Thalís 15 / Creta in thalís 15  
Creta pág. izquierda en Thalís 04  
Creta, opposit page in thalís 04 / Creta page gauche en thalís 04

# Creta

Un clásico renovado que se nos para la búsqueda de soluciones en las que prima la madurez y la exigencia estética. Atemporalidad, classicismo, sobriedad... Encuentre en PAULA la solución que busca envuelta en estos conceptos si realmente responden a su estilo.

Renovated classic which converts contemporary, providing us subtlety and strength. Its strong and voluptuous volumes suggest stability, serenity and trust. Timelessness. Classicism, temperance, find in PAULA the solution you are looking for, wrapped in these concepts if really is your style.

Le classique renouvelé, le quel semble contemporain, Il nous apporte subtilité et une solidité... Ses volumes voluptueux et contondants nous suggèrent une stabilité, une sérénité et une confiance. Il semble idéal pour la recherche de solutions dans lesquelles il prime la maturité et l'exigence esthétique. La atemporalité, le classicisme, la sobriété... Trouvez vous dans PAULA la solution que vous cherche enveloppée de ces concepts, si il est son style.



Creta en Thalys 05  
Creta in thalys 05 / Creta en thalys 05



Creta en Thalys 11  
Creta in thalys 11 / Creta en thalys 11



1. Creta en Thalys 12 - 2. Creta en Thalys 10  
1. Creta in thalys 12 - 2. Creta in thalys 12 / 1. Creta in thalys 10 - 2. Creta in thalys 10











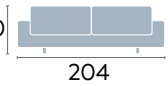
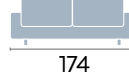

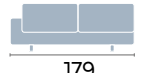
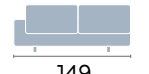



Creta

Creta en Thalys 14  
Creta en thalys 14 / Creta in thalys 14

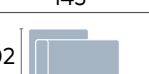
**DVN**  
S T A R  
La marca que mejor te sienta

# Creta

Tarifa por puntos/rate/tarif	medidas / measurements / mesures	Series telas / Fabrics series / Série de tissus									Metroje	Nº Decorativos	Cubicoje M <sup>3</sup>
		Largo	Fondo	Altura	G/0	G/1	G/2	G/3	G/4	T Cliente			
100  204	Creta 3 pl a 2,04	204	100	100	432	458	491	520	551	410	12,5	-	1,26
 174	Creta 2 pl	174	100	100	392	416	446	473	501	372	11,2	-	1,08
 112	Creta 1 pl	112	100	100	307	326	349	370	392	292	8,25	-	0,69
 179	Creta mod 3 pl 1/br	179	100	100	416	441	472	500	530	395	11	-	1,11
 149	Creta mod 2 pl 1/br	149	100	100	370	393	421	446	473	352	9,2	-	0,92
 102	Creta mod 1 pl c/76 1/br	102	100	100	307	326	349	370	392	292	7	-	0,74
 88	Creta mod 1 pl c/62 1/br	88	100	100	297	316	339	359	381	282	6,1	-	0,55
 154	Creta mod 3 pl s/br	154	100	100	396	420	450	477	506	376	9,2	-	0,95
 124	Creta mod 2 pl s/br	124	100	100	350	371	397	421	446	333	7,5	-	0,77
 76	Creta mod 1 pl c/76 s/b	76	100	100	287	305	327	347	368	273	5,5	-	0,48
 62	Creta mod 1 pl c/62 s/b	62	100	100	277	295	317	336	356	263	4,2	-	0,38
102  145	Creta chaiselón 1,02 x 1,45	102	145	100	330	350	375	398	422	314	8,2	1 DECO 50*50	0,92
102  175	Creta chaiselón 1,02 x 1,75	102	175	100	376	399	427	453	480	357	10	2 DECO 50*50	1,11
106  175	Creta chaiselón largo brazo arcon 1,06 x 1,75	106	175	100	396	419	447	474	502	376	10	2 DECO 50*50	1,15
100  200	Creta chaiselón largo terminal 1,00 x 2,00	100	200	100	401	431	475	504	534	381	10,75	-	1,24
110  110	Creta mod rincón	110	110	100	376	399	427	453	480	357	7	-	0,75



Creta en Thalys 05  
Creta in thalys 05 / Creta en thalys 05

## Características técnicas / Technical characteristics / Caractéristiques techniques

- |   |  |   |
|---|--|---|
| <ul style="list-style-type: none"> <li>• ESTRUCTURA: MADERA DE PINO.</li> <li>• RECUBRIMIENTO ESPUMA DE POLIURETANO DE 1,5 CM.</li> <li>• ALMOHADAS ASIENTOS: GOMA 35 KG. "BULFLEX".</li> <li>• ALMOHADAS RESPALDO: FIBRA ALTA RESISTENCIA "OPTIFIBRE".</li> <li>• COJINES RESPALDO: RECLINABLES. CABEZAL METÁLICO.</li> <li>• COJINES ASIENTO EXTRAÍBLE. CARRO METÁLICO.</li> <li>• PATAS: METÁLICAS.</li> </ul> | <ul style="list-style-type: none"> <li>• STRUCTURE: PINE WOOD.</li> <li>• RECOVERY: LAY OF POLYURETHANE 1.5 CM.</li> <li>• SEAT CUSHION: HR FOAM 35 KG "BULFLEX" EXTENSIBLE WITH CART.</li> <li>• BACK CUSHION: HIGH RESISTANCE FIBER"OPTIFIBER".</li> <li>• ADJUSTABLE METALLIC HEADREST.</li> <li>• LEGS: METALLIC.</li> </ul> | <ul style="list-style-type: none"> <li>• STRUCTURE: BOIS DE PIN.</li> <li>• RECOUVREMENT: COUCHE DE POLYURÉTHANE 1.5 CM.</li> <li>• COUSSIN D'ASSISE: MOUSSE HR 35 KG "BULFLEX", EXTRAIBLE AVEC CHARIOT.</li> <li>• COUSSIN DE DOSSIER: FIBRE HAUTE RÉSISTANCE "OPTIFIBER".</li> <li>• TÊTIÈRE MÉTALLIQUE AJUSTABLE.</li> <li>• PIÈTEMENT: MÉTALLIQUE.</li> </ul> |
|---|--|---|



**OVN**<sup>®</sup>  
**S T A R**

La marca que mejor te sienta



**DVN**<sup>®</sup>  
S T A R  
La marca que mejor te sienta



# Daytona

Daytona en Sioux 5  
Daytona in sioux 05 / Dayton en sioux 05  
Daytona pág. izquierda en Sioux 10  
Daytona in sioux 10 / Daytona en sioux 10



## Daytona

Daytona es un modelo de sofá relax cuyo diseño se caracteriza especialmente por sus proporcionados volúmenes, perfilados por su cabezal y brazos regulables. Su grado de confortabilidad es excelente.

Daytona is a relax couch model with special design based on provided volumes, profiled in adjustable arms and adjustable heads supports. Has an excellent level of comfort.





Est un modèle de canapé relax dont le dessin est caractérisé par ses Volumes proportionnés et profilés par son oreiller du tête et des bras réglables. Son confortabilité est excellent.





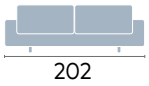
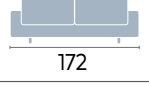

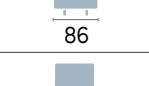
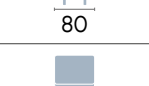
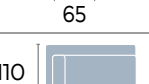
# Daytona

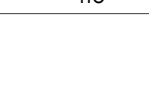
Tarifa por puntos/rate/tarif	medidas / measurements / mesures	Series telas / Fabrics series / Série de tissus					Series piel / Leather series / Série cuir				Metroje	Nº Decorativos	Cubicaje M <sup>3</sup>				
		Largo	Fondo	Altura	G/0	G/1	G/2	G/3	G/4	T Cliente				Piel 1	Piel 2	Piel 3	Piel 4
 202	Daytona 3 pl a 2,02	202	105	100	605	628	660	700	742	569	813	849	934	1027	13	-	1,89
 172	Daytona 2 pl	172	105	100	583	605	637	675	716	546	794	830	913	1004	12	-	1,61
 107	Daytona 1 pl	107	105	100	335	343	361	383	406	317	451	461	507	558	9	-	1,00
 101	Daytona mod. 1 Pl a 1,011/b	101	105	100	304	315	330	350	371	285	407	425	468	515	7	-	0,94
 86	Daytona mod. 1 Pl a 0,861/b	86	105	100	291	303	319	338	358	273	397	415	457	503	6,5	-	0,80
 80	Daytona mod. 1 Pl a 0,80 s/b	80	105	100	285	297	312	331	351	267	371	397	437	481	6	-	0,75
 65	Daytona mod. 1 Pl a 0,65 s/b	65	105	100	273	280	301	319	338	255	361	389	428	471	5,2	-	0,61
 174	Daytona tumbona	110	174	100	338	352	371	393	417	214	643	674	741	815	9,5	2 DECO 50*50	1,70
 110	Daytona mod. Rincón	110	110	100	340	360	380	403	427	310	590	619	681	749	9	-	1,08

## Características técnicas / Technical characteristics / Caractéristiques techniques

- ESTRUCTURA: MADERA DE PINO.
- MECANISMO: RELAX METÁLICO.
- RECUBRIMIENTO: ESPUMA DE POLIURETANO 1,5 CM.
- ALMOHADAS ASIENTOS: ASIENTO HR 30 KG CON FIBRA DE 400 GR.
- ALMOHADAS RESPALDO: FIBRA ALTA RESISTENCIA "OPTIFIBRE".
- COJINES DE ASIENTO: RELAX ELECTRICO MOTORIZADO (FIJO SIN RELAX SE DESCUENTA 52 PUNTOS).
- PATAS DELANTERAS METÁLICAS. TRASERAS PVC (patas plástico).
- RESPALDO ABATIBLE
- ESTE MODELO, SIEMPRE QUE VAYA TAPIZADO EN PIEL, NO INCLUIRÁ DECORATIVOS DE SERIE EN NINGUNA DE SUS MODULACIONES
- COJINES DE RESPALDO: ABATIBLES.
- COJINES DE RESPALDO ABATIBLE MANUAL.
- STRUCTURE PINE WOOD.
- ELECTRIC RELAX MECANISME.
- RECOVERY: LAYER OF POLYURETHANE FOAM 1,5 CM.
- SEAT CUSHION HR FOAM 30 KG WITH A LAYER OF 400 GR FIBER ON TOP.
- SEAT WITH MOTORIZED RELAX MECANISME (WITHOUT MOTOR 52 POINTS LESS).
- BACK CUSHION HIGH RESISTANCE FIBER "OPTIFIBER".
- LEGS : METAL
- DOSSIER RECLINABLE
- THERE IS NO PILLOW INCLUDED IN THIS MODEL WHEN MADE IN LEATHER
- ADJUSTABLE HEADREST
- STRUCTURE BOIS DE PIN.
- MÉCANISME RELAX ÉLECTRIQUE.
- RECOUVREMENT COUCHE DE MOUSSE POLYURÉTHANE DE 1,5 CM.
- COUSSIN D'ASSISE MOUSSE HR 30 KG AVEC COUCHE DE FIBRE DE 400 GR SUR LA PARTIE SUPÉRIEUR.
- SANS ASSISE MOTORISÉE, 52 POINTS DE MOINS.
- COUSSIN DE DOSSIER FIBRE DE HAUTE RÉSIDENCE "OPTIFIBRE".
- PIÈTEMENT MÉTALLIQUE.
- RECLINABLE HEADREST
- CE MODELE N'INCLUT PAS DE DECOS LORSQU'IL EST FABRIQUÉ EN CUIR.
- TÊTIÈRES MANUELLEMENT REGULABLES

## Opciones de patas / Leg options / Options de jambe

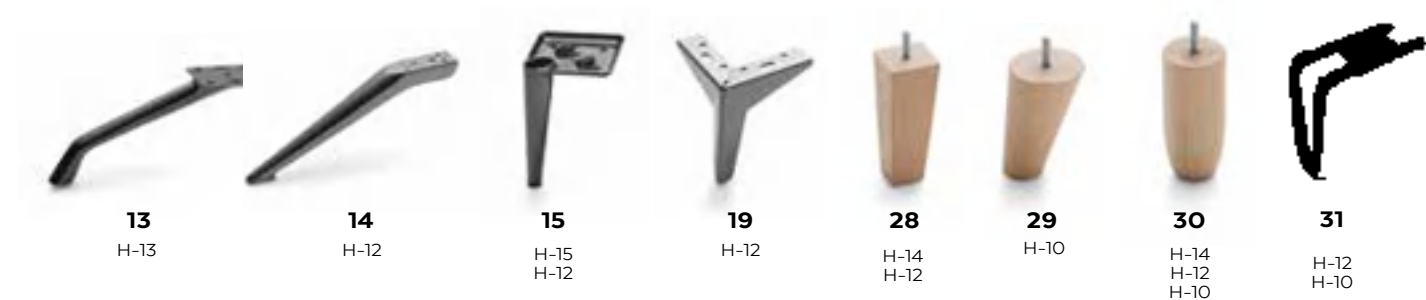

El cambio de pata puede suponer un incremento en el precio. / Le changement de piètement peut entrainer un supplément sur le prix. / Change of legs could lead to a supplement.





**DVN**<sup>®</sup>  
S T A R  
La marca que mejor te sienta

Enara en piel Modena Blue  
Enara in blue moderna leather / Enara en cuir moderna bleu

**Enara**



Enara en piel Módena Grigio  
*Enara in Grigio modena leather / Enara eu cuir modena grigio*



Enara en piel Módena Terracota  
*Enara in terracota modena leather / Enara en cuir modena terracota*

## Enara

Enara es espectacular, impecable por donde lo mires. Unas proporciones optimizadas que armonizan a la perfección con su diseño. Se percibe como enormemente cómodo y arrasa en personalidad.





Enara is a spectacular and perfect model from any point of view. Its optimized proportions are in perfect harmony with its design. It looks highly comfortable and triumph in personality.

Enara est spectaculaire sur tous les plans. Il est constitué de proportions en parfaite harmonie avec son motif. Il est perçu comme extrêmement confortable avec une personnalité extraordinaire ..

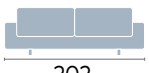
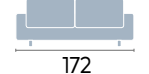

# Enara

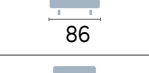
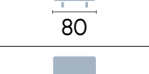
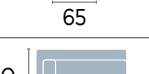
Enara en piel Módena Lino  
Enara in lino modena leather / Enara en cuir modena lino

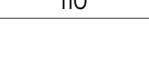
Tarifa por puntos/rate/tarif	medidas / measurements / mesures	Series telas / Fabrics series / Série de tissus								Series piel / Leather series / Série cuir				Metroje	Nº Decorativos	Cubicaje M <sup>3</sup>	
		Largo	Fondo	Altura	G/0	G/1	G/2	G/3	G/4	T Cliente	Piel 1	Piel 2	Piel 3				Piel 4
100  202	Enara 3 pl	202	105	100	635	659	693	735	779	597	854	891	980	1078	13,5	-	1,80
 172	Enara 2 pl	172	105	100	612	635	669	709	752	582	834	872	959	1055	10,5	-	1,54
 107	Enara 1 pl	107	105	100	352	360	379	402	426	333	474	484	532	585	6,2	-	0,95
 102	Enara mod 1 pl 1/br	102	105	100	319	331	347	368	390	299	427	446	491	540	6	-	0,90
 86	Enara mod 1 pl 1/br	86	105	100	306	318	335	355	376	287	417	436	480	528	5,3	-	0,77
 80	Enara mod 1 pl s/br	80	105	100	299	312	328	348	369	280	390	417	459	505	3,6	-	0,71
 65	Enara mod 1 pl s/br	65	105	100	287	294	316	335	355	268	379	408	449	494	3,3	-	0,58
110  174	Enara tumbona	110	174	100	355	370	390	413	438	225	675	708	779	857	9,2	2 DECO 50*50	1,62
110  110	Enara mod. Rincón	110	110	100	357	378	399	423	448	326	620	650	715	787	9,4	-	1,03



Enara en piel Módena Lilla  
Enara in Lilla modena leather / Enara en cuir modena Lilla

## Características técnicas / Technical characteristics / Caractéristiques techniques

- ESTRUCTURA: MADERA DE PINO Y PARTÍCULAS
- ESTRUCTURA BRAZOS Y RESPALDOS: MADERA DE PARTÍCULAS
- RECUBRIMIENTO: ESPUMA DE POLYURETANO 1.5 CM
- ALMOHADAS ASIENTOS: ASIENTO HR 30 KG CON FIBRA 400 GR
- ALMOHADAS RESPALDO: FIBRA DE ALTA RESISTENCIA "OFTIFIBRE"
- COJINES RESPALDO: CABEZAL ARTICULADO MANUAL
- COJINES ASIENTO RELAX MOTORIZADO, SE DESCUENTAN 52 PUNTOS SI ES FIJO
- PATAS METÁLICAS
- ESTE MODELO, SIEMPRE QUE VAYA TAPIZADO EN PIEL, NO INCLUIRÁ DECORATIVOS DE SERIE EN NINGUNA DE SUS MODULACIONES.
- OPCIÓN CABEZAL ELECTRICÓ: INCREMENTO DE 40 PUNTOS POR MÓDULO CON CABEZAL MOTORIZADO.
- EN EL MÓDULO TUMBONA SOLO DISPONIBLE OPCIÓN CABEZAL MANUAL.

- STRUCTURE: BOIS DE PIN ET DE PARTICULES
- STRUCTURE ACCOUDOIRS ET DOSSIER: BOIS DE PARTICULES
- RECOUVREMENT: COUCHE DE POLYURÉTHANE 1.5 CM
- COUSSIN D'ASSISE: MOUSSE HR 30 KG SURPLOMBÉE DE 400 GR DE FIBRE
- COUSSIN DE DOSSIER: FIBRE DE HAUTE RESISTANCE (OFTIFIBRE)
- TÊTIÈRE : RÉGULABLE MANUELLEMENT
- ASSISE MOTORISÉE , REMISE POUR ASSISE FIXE 52 POINTS
- PIÈTEMENT: MÉTALLIQUE
- THIS MODEL IN LEATHER DOESN'T INCLUDE PILLOWS
- OPTION ELECTRIC HEADREST: THERE IS AN INCREASING OF 40 POINTS FOR EACH SEAT THEREFORE THERE IS NO OPTION OF ELECTRIC.
- HEADREST FOR TUMBONA OR CHAISELONG. THEY ARE MANUAL

- STRUCTURE: PINE WOOD AND PARTICLES
- STRUCTURE ARMREST AND BACKREST: WOOD PARTICLES
- RECOVERY: LAYER OF POLYURETHANE 1.5 CM
- SEAT CUSHION: HIGH RESISTANT FOAM 30 KG WITH 400GR FIBER ON TOP
- BACK CUSHION: HIGH RESISTANT FIBER (OPTIFIBER)
- HEADREST: ADJUSTABLE MANUALLY
- MOTORIZED SEAT. WITHOUT ANGINE (RELAX) 52 POINTS LESS
- LEGS: METAL
- EN CUIR CE MODELE N'INCLUT PAS DE DECOS.
- OPTION TÊTIÈRE ÉLECTRIQUE: IL Y'A UN SUPPLÈMENT DE 40 POINTS PAR ASSISE.
- CEPENDANT POUR LES TUMBONA OU CHAISELONGUES, SEULE L'OPTION TÊTIÈRE MANUELLE EST POSSIBLE



Enara en piel Módena Mostarda  
Enara in mostarda modena leather / Enara en cuir modena mostarda



Enara en piel Módena Turchese  
Enara in Turches modena leather / Enara en cuir modena turquesa

## Opciones de patas / Leg options / Options de jambe

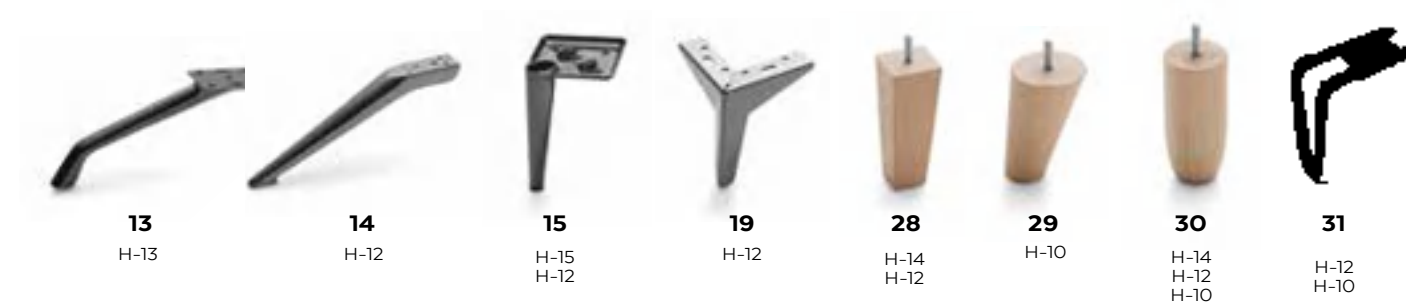

El cambio de pata puede suponer un incremento en el precio. / Le changement de piètement peut entraîner un supplément sur le prix. / Change of legs could lead to a supplement.

Silver en Dolxe 3006, vivo en color frambuesa  
Silver in Dolxe 3006, piping in purple / Silver en dolxe 3006, passepoil en violet  
Silver pág. derecha en Dolxe 3006, vivo en color verde  
Silver in dolxe 3006 , piping in green / Silver en dolxe 3006 , passepoil en vert



**DVN**<sup>®</sup>  
S T A R  
La marca que mejor te sienta



**Silver**



Silver en Dolxe 3007, vivo en color gris oscuro y decorativos en Dolxe 3006  
Silver in Dolxe 3007, piping in dark grey, pillows in Dolxe 3006  
Silver en Dolxe 3007, passepoil en gris obscur, coussins deco en dolxe 3006

## Silver

Exquisitez en sus acabados que podemos apreciar en cualquier detalle que elijamos. El tipo de cosido en el acabado de brazos le permite enriquecer su aspecto, combinando incluso distintos colores.

This model wears a decorative cushion by each series arm. Exquisite finishes that we can appreciate in every detail that we choose. The kind of sewing in the arm's finish allow us enrich its aspect, mixing different colors.

Une exquisité dans ses terminés que nous pouvons apprécier dans n'importe quel détail que nous choisissons. Le type de couture dans achevé des bras lui permet d'enrichir son aspect, en combinant même des couleurs distinctes.





## Silver

1. Silver en Dolxe 3006, vivo en color marrón  
*Silver in dolxe 3006, piping in brown / Silver en dolxe 3006, passepoil en marron*
2. Silver en Dolxe 3005, vivo en color marrón oscuro  
*Silver in dolxe 3005, piping in brown / Silver en dolxe 3005, passepoil en marron*

# Silver

Tarifa por puntos/rate/tarif	medidas / measurements / mesures			Series telas / Fabrics series / Série de tissus						Series piel / Leather series / Série cuir				Metroje	Nº Decorativos	Cubicaje M <sup>3</sup>	
	Largo	Fondo	Altura	G/0	G/1	G/2	G/3	G/4	T Cliente	Piel 1	Piel 2	Piel 3	Piel 4				
95  204	Silver 3 pl 2,04 (2rx)	204	90	95	715	746	781	828	878	682	930	968	1045	1101	13,5	2 DECO 50*50	1,60
184	Silver 3 pl 1,84 (2rx)	184	90	95	682	713	748	793	841	649	895	934	1012	1068	11,9	2 DECO 50*50	1,44
154	Silver 2 pl 1,54 (2rx)	154	90	95	649	680	715	758	803	616	862	901	978	1035	11	2 DECO 50*50	1,21
89	Silver 1 pl (rx)	89	90	95	358	373	391	414	439	341	468	484	548	574	9	-	0,70
102	Silver mod. 1 Pl 1/b 1,02 (rx)	102	90	95	358	373	391	414	439	341	468	484	548	574	7	1 DECO 50*50	0,80
92	Silver mod. 1 Pl 1/b 0,92 (rx)	92	90	95	341	357	374	396	420	325	447	468	531	560	6,25	1 DECO 50*50	0,73
77	Silver mod. 1 Pl 1/b 0,77 (rx)	77	90	95	325	340	358	379	402	308	432	450	515	543	6	1 DECO 50*50	0,61
90	Silver mod. 1 Pl s/b 0,90 (rx)	90	90	95	340	356	373	395	419	324	446	467	530	559	5,4	-	0,71
80	Silver mod. 1 Pl s/b 0,80 (rx)	80	90	95	330	346	363	385	408	314	418	440	504	532	4,7	-	0,63
65	Silver mod. 1 Pl s/b 0,65 (rx)	65	90	95	308	324	341	361	383	292	396	418	482	510	4,4	-	0,52
110  110	Silver mod. Rincón	110	110	95	440	473	506	536	568	429	550	605	710	798	8,5	-	1,06



Silver en Dolxe 3006, vivo en color frambuesa  
Silver in Dolxe 3006, piping in purple  
Silver en dolxe 3006, passepoil en violet

## Características técnicas / Technical characteristics / Caractéristiques techniques

- ESTRUCTURA: MADERA DE PINO COMBINADO CON DM 18 MM
  - RECUBRIMIENTO: ESPUMA DE POLIURETANO COMBINADO CON FLOCA DE 300 GR.
  - ALMOHADAS ASIENTOS: BLOQUE DE ESPUMA DE POLIURETANO SR2 (VEFER), COMBINADO CON FLOCA DE 300 GR.
  - ALMOHADAS RESPALDO: BLOQUE DE ESPUMA DE 20 KG SS, COMBINADO CON FLOCA DE 300 GR.
  - COJÍN ASIENTO: FIJO SIN RELAX , DTO 52 PUNTOS POR ASIENTO.
  - PATAS: METÁLICAS
  - ESTE MODELO, SIEMPRE QUE VAYA TAPIZADO EN PIEL, NO INCLUIRÁ DECORATIVOS DE SERIE EN NINGUNA DE SUS MODULACIONES
- STRUCTURE: PINE WOOD COMBINED WITH 18 MM OF DM
  - RECOVERY: LAYER OF POLYURETHANE FOAM COMBINED WITH 300 GR OF COMPACTED FIBRE
  - SEAT CUSHION: BLOCK OF POLYURETHANE FOAM COMBINED WITH 300 GR OF COMPACTED FIBRE
  - BACK CUSHION: BLOCK OF FOAM 22 KG COMBINED WITH 300 GR OF COMPACTED FIBRE
  - SEAT: ELECTRIC RELAX (WITHOUT RELAX , 52 POINTS LESS PER SEAT)
  - LEGS: METAL
  - SUR CE MODEL EN CUIR , IL N'Y A PAS DE DECOS INCLUS
- STRUCTURE: BOIS DE PIN COMBINÉ AVEC 18 MM DE DM
  - RECOUVREMENT: COUCHE DE MOUSSE POLYURÉTHANE COMBINÉ AVEC 300 GR DE FIBRE COMPACTÉE
  - COUSSIN D'ASSISE: BLOQUE DE MOUSSE POLYURÉTHANE (VEFER) COMBINÉ AVEC 300 GR DE FIBRE COMPACTÉE
  - COUSSIN DE DOSSIER: BLOQUE DE MOUSSE DE 20 KG COMBINÉ AVEC 300 GR DE FIBRE COMPACTÉE
  - ASSISE: RELAX MOTORISÉ (SANS RELAX , MOINS 52 POINTS PARA SSISE)
  - PIÈTEMENT: MÉTALLIQUE.
  - THERE IS NO PILLOW INCLUDED IN THIS MODEL WHEN MADE IN LEATHER



Silver en Dolxe 3007, vivo en color gris oscuro y decorativos en Dolxe 3006  
Silver in Dolxe 3007, piping in dark grey, pillows in Dolxe 3006  
Silver en Dolxe 3007, passepoil en gris obscur, coussins deco en dolxe 3006



Silver en Dolxe 3006, vivo en color verde  
Silver in dolxe 3006, piping in green / Silver en dolxe 3006, passepoil en vert



**DVN**<sup>®</sup>  
S T A R  
La marca que mejor te sienta









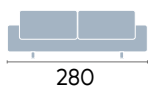
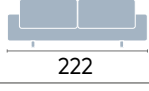
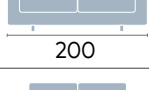
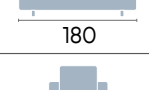

# Vecchio

Vecchio en Thalys 10  
Vecchio in thalys 10 / Vecchio en thalys 10  
Vecchio pág. izquierda en Thalys 19  
Vecchio in thalys 19 / Vecchio en thalys 19

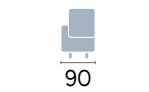
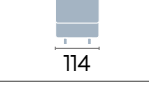
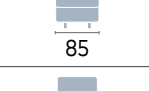

Vecchio en Thalys 19 - Rosalía en piel Módena Mostarda  
Vecchio in thalys 19 + Rosalia chair in leather Modena mostarda / Vecchio en thalys 19 + fauteuil Rosalia en cuir modena mostarda.

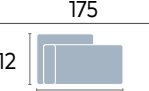
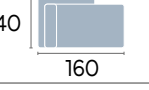
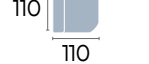
# Vecchio

Tarifa por puntos/rate/tarif	medidas / measurements / mesures	Series telas / Fabrics series / Série de tissus								Series piel / Leather series / Série cuir				Metraje	Nº Decorativos	Cubiçaje M <sup>3</sup>	
		Largo	Fondo	Altura	G/0	G/1	G/2	G/3	G/4	T Cliente	Piel 1	Piel 2	Piel 3				Piel 4
100 	Vecchio 3 pl a 2,80 (rx)	280	102	100	816	857	898	952	1009	776	1166	1236	1360	1496	13,5	-	2,55
	Vecchio 3 pl a 2,22 (b1+b1)	222	102	100	618	641	674	714	757	581	876	928	1021	1123	12	-	2,01
	Vecchio 3 pl a 2,00 (b+b2)	200	102	100	604	627	659	714	757	568	814	850	935	1029	11,8	-	1,82
	Vecchio 2 pl (b3+b)	180	102	100	595	618	650	699	741	557	794	830	913	1004	10,2	-	1,64
	Vecchio 1 pl (rx)	117	102	100	342	350	369	689	730	324	451	461	507	558	6	-	1,06
	Vecchio mod. 1 Pl a 1,40 (rx) 1/b	140	102	100	408	429	449	391	414	388	583	618	680	748	7	-	1,27
	Vecchio mod. 1 Pl a 1,11 (rx) (b1) 1/b	111	102	100	311	322	337	476	505	291	438	464	510	561	5,9	-	1,01
	Vecchio mod. 1 Pl a 1,00 (rx) (b2) 1/b	100	102	100	303	314	330	357	378	285	407	425	468	515	5,7	-	0,91
	Vecchio mod. 1 Pl a 0,90, (rx) (b3) 1/b	90	102	100	297	310	326	350	371	279	397	415	457	503	5	-	0,82
	Vecchio mod. 1 Pl a 1,14 (rx) s/b	114	102	100	419	431	446	346	367	399	574	607	668	735	5,9	-	1,03
	Vecchio mod. 1 Pl a c/84 (rx) (b4) s/b	85	102	100	291	303	319	473	501	273	413	436	480	528	5	-	0,77
	Vecchio mod. 1 Pl a c/74 (rx) (b5) s/b	74	102	100	285	295	312	338	358	267	371	397	437	481	4,5	-	0,67
	Vecchio mod. 1 Pl a c/64 (rx) (b6) s/b	64	102	100	279	304	308	331	351	261	361	389	428	471	4,2	-	0,58
112 	Vecchio chaiselóngue 1,12 x 1,75	112	175	100	330	344	363	326	346	206	472	499	549	604	9,8	2 DECO 50*50	1,74
112 	Vecchio chaiselóngue brazo arcón 1,12 x 1,75	112	175	100	350	364	383	385	408	226	497	525	578	636	11,5	2 DECO 50*50	1,74
140 	Vecchio chaiselóngue brazo arcón 1,40 x 1,60	140	160	100	429	439	454	406	430	408	589	623	685	754	12	2 DECO 50*50	1,99
110 	Vecchio mod. Rincón	110	110	100	347	368	388	481	510	317	504	533	586	645	10,2	-	1,08



Vecchio en Thalys 03  
Vecchio in thalys 03 / Vecchio en thalys 03

## Características técnicas / Technical characteristics / Caractéristiques techniques

- ESTRUCTURA: MADERA DE PINO Y PARTÍCULAS.
- RECUBRIMIENTO ESPUMA DE POLIURETANO DE 1,5 CM.
- ALMOHADAS ASIENTOS: ASIENTO HR 30 KG. CON FIBRA 400 GR.
- ALMOHADAS RESPALDO: FIBRA ALTA RESISTENCIA "OPTIFIBRE".
- COJINES ASIENTO RELAX MOTORIZADO (FIJO SIN RELAX , DTO. 52 PUNTOS).
- COJINES RESPALDO: MECANISMO ABATIBLE.
- OPCIÓN RESPALDO MOTORIZADO INCREMENTO 40 PUNTOS POR RESPALDO, MOD. 1,14 M Y 1,40 M INCREMENTO 60 PUNTOS.
- PATAS METÁLICAS, TRASERAS PVC (PATAS DE PLÁSTICO).
- ESTE MODELO, SIEMPRE QUE VAYA TAPIZADO EN PIEL, NO INCLUIRÁ DECORATIVOS DE SERIE EN NINGUNA DE SUS MODULACIONES.
- SE PUEDEN REDUCIR LOS BRAZOS DEL MODELO EN 5 CM SIN INCREMENTO EN LA TARIFA , A EXCEPCIÓN DE LOS BRAZOS DE LOS DIFERENTES CHAISÉLONGUES QUE NO ADMITIRÁN REDUCCIÓN ALGUNA.
- STRUCTURE PINE WOOD AND WOOD PARTICLES.
- RECOVERY: POLYURETHANE FOAM 1.5 CM.
- SEAT CUSHION HR FOAM 30 KG + 400 GR OF FIBER.
- BACKREST CUSHION HIGH RESISTANCE FIBER (OPTIFIBER).
- MOTORIZED SEAT ( WITHOUT ENGIN 52 POINTS LESS).
- BACK CUSHION: REMOVABLE .
- MOTORIZED HEADREST: 40 POINT FOR 1.14 AND 60POINTS FOR 1.40.
- LEGS: METAL.
- THIS MODEL IN LEATHER DOES NOT INCLUDE DECORATIVE PILLOWS.
- ARMREST CAN BE MADE 5 CM LESS WIDE IN THIS MODEL WITHOUT COST EXCPT ON CHAISÉLONGS
- STRUCTURE BOIS DE PIN ET BOIS DE PARTICULES.
- RECOUVREMENT: MOUSSE POLYURÉTHANE 1.5 CM.
- COUSSIN D'ASSISE MOUSSE HR 30 KG + 400 GR DE FIBRE.
- COUSSIN DE DOSSIER FIBRE HAUTE RÉSIDENCE "OPTIFIBRE".
- ASSISE MOTORISÉE (FIXE SANS RELAX 52 DE MOINS).
- COUSSIN DE DOSSIER: MÉCANISME ABATIBLE.
- OPTION MOTORISATION TÊTIÈRE :SUPPLÉMENT DE 40 PTS POUR LE 1.14 ET 60 PTS POUR LE 1.40.
- PIÈTEMENT MÉTALLIQUE.
- CE MODELE EN CUIR N'INCLUT PAS DE DECOS.
- ON PEUT REDUIR 5 CM DES ACCOUDOIRS DE CE MODEL A L'EXCEPTION DES CHAISÉLONGUES.



**DVNI**<sup>®</sup>

**S T A R**

La marca que mejor te sienta

Bon en piel Módena TDM  
Bon in modena leather TDM / Bon en cuir modena TDM  
Bon pág. derecho en piel Módena Cappuccino  
Bon in modena leather c/cappuccino / Bon en cuir modena couleur capuccino



**DVN**<sup>®</sup>  
S T A R  
La marca que mejor te sienta

**Bon**











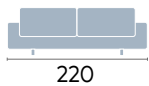
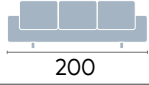
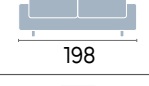

Bon en piel Módena Granato  
*Bon en cuir modena rouge bordeaux / Bon in deep red modena leather*  
Bon pág. derecha en piel Módena Tortora  
*Bon in tortora modena leather / Bon en cuir modena tortora*

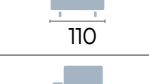

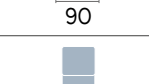
**Bon**

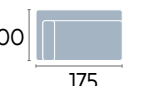
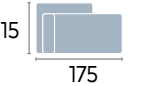
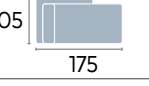

# Bon

Tarifa por puntos/rate/tarif	medidas / measurements / mesures	Series telas / Fabrics series / Série de tissus					Series piel / Leather series / Série cuir				Metroaje	Nº Decorativos	Cubicaje M <sup>3</sup>				
		Largo	Fondo	Altura	G/0	G/1	G/2	G/3	G/4	T Cliente				Piel 1	Piel 2	Piel 3	Piel 4
95 	Bon 3 Pl a 2,20 (b1+b1)	220	100	95	605	628	660	700	742	569	813	849	934	1027	14	2 DECO 50*50	2,01
200 	Bon 3 Pl a 2,00 (b2+b2)	200	100	95	592	614	646	685	726	556	804	840	924	1016	13,3	2 DECO 50*50	1,82
198 	Bon 2 Pl (b3+b3)	198	100	95	583	605	637	675	716	546	794	830	913	1004	12,3	2 DECO 50*50	1,80
128 	Bon 1 Pl	128	100	95	335	343	361	383	406	317	451	461	507	558	8,2	-	1,17
110 	Bon Mod. 1 Pl a 1,10 (b1) 1/b	110	100	95	304	315	330	350	371	285	407	425	468	515	7,3	1 DECO 50*50	1,01
100 	Bon Mod. 1 Pl a 1,00 (b2) 1/b	100	100	95	297	307	323	342	363	279	402	420	462	508	6,7	1 DECO 50*50	0,91
90 	Bon Mod. 1 Pl a 0,90 (b3) 1/b	90	100	95	291	303	319	338	358	273	397	415	457	503	6,4	1 DECO 50*50	0,83
85 	Bon Mod. 1 Pl a 0,85 (b4) s/b	85	100	95	285	297	312	331	351	267	371	397	437	481	5,4	-	0,78
75 	Bon Mod. 1 Pl a 0,75 (b5) s/b	75	100	95	279	289	305	323	342	261	375	384	422	464	4,8	-	0,68
65 	Bon Mod. 1 Pl a 0,65 (b6) s/b	65	100	95	273	280	301	319	338	255	361	389	428	471	4,5	-	0,60
110 	Bon Tumbona arcón 1,10*1,75 (b7)	110	175	95	271	295	325	345	366	253	497	515	567	624	9,8	2 DECO 50*50	1,76
100 	Bon Tumbona arcón 1,00*1,75 (b8)	100	175	95	262	285	316	335	355	244	487	505	556	612	9,5	2 DECO 50*50	1,59
115 	Bon chaiselongue m.V.1 1,15 *1,75	115	175	95	271	295	325	345	366	253	497	515	567	624	9,5	2 DECO 50*50	1,83
105 	Bon chaiselongue m.V.1 1,05 *1,75	105	175	95	262	285	316	335	355	244	487	505	556	612	8,7	2 DECO 50*50	1,68
110 	Bon Mod. Rincón	110	110	95	340	360	380	403	427	310	590	619	681	749	7,8	-	1,10



Bon en piel Módena Terracota  
Bon in terracota modena leather / Bon en cuir madena terracota  
Bon arriba en piel Módena TDM  
Bon in TDM Modena leather / Bon en CUIR MODENA TDM

## Características técnicas / Technical characteristics / Caractéristiques techniques

- ESTRUCTURA: MADERA DE PINO Y PARTÍCULAS.
- RECUBRIMIENTO: ESPUMA DE POLIURETANO DE 1,5 CM.
- ALMOHADAS ASIENTOS: ASIENTO HR 30 KG CON FIBRA S.S DE 400 GR.
- ALMOHADAS RESPALDO: FIBRA SILICONADA "OPTIFIBRE".
- COJINES DE ASIENTO: RELAX MOTORIZADO TACTIL (FIJO SIN RELAX SE DESCUENTA 52 PUNTOS).
- PATAS: METÁLICAS.
- ESTE MODELO, SIEMPRE QUE VAYA TAPIZADO EN PIEL, NO INCLUIRÁ DECORATIVOS DE SERIE EN NINGUNA DE SUS MODULACIONES.
- SE PUEDEN REDUCIR LOS BRAZOS DEL MODELO EN 5 CM SIN INCREMENTO EN LA TARIFA, A EXCEPCIÓN DEL BRAZO DEL CHAISÉLONGUE DEL MISMO.
- STRUCTURE PINE WOOD AND WOOD PARTICLES.
- RECOVERY: LAYER OF POLYURETHANE FOAM OF 1.5 CM.
- SEAT CUSHION HR FOAM 30 KF WITH 400 GR FIBER S.S ON TOP.
- BACK CUSHION: SILICONED FIBER "OPTIFIBER".
- ELECTRIC RELAX SEAT WITH TACTILE SYSTEM. WITHOUT RELAX, 52 POINTS LESS.
- LEGS: METAL.
- THERE IS NO PILLOW INCLUDED IN THIS MODEL WHEN MADE IN LEATHER.
- WE CAN REDUCE 5 CM THE WIDTH OF THE ARMRESTS OF THIS MODEL EXCEPT ON CHAISÉLONGUE.
- STRUCTURE BOIS DE PIN ET BOIS DE PARTICULES.
- RECOUVREMENT COUCHE DE MOUSSE POLYURÉTHANE DE 1.5 FCM.
- COUSSIN D'ASSISE MOUSSE HR DE 30 KG AVEC 400 GR DE FIBRE S.S.
- COUSSIN DE DOSSIER: FIBRE SILICONÉ "OPTIFIBRE".
- ASSISE RELAX ÉLECTRIQUE AVEC COMMANDE TACTILE. FIXE, SANS SYSTÈME RELAX, MOINS 52 POINTS.
- PIÈTEMENT MÉTALLIQUE.
- CE MODELE EN CUIR N'INCLUT PAS DE DECOS
- LES ACCOUDOIRS DE CE MODELE PEUVENT SE REDUIRE DE 5 CM, SUR LES MODULES, PAS SUR LES CHAISÉLONGUES



**DVN**<sup>®</sup>  
S T A R  
La marca que mejor te sienta



# Maxim

Maxim en Fabia 3  
Maxim in rustika Fabia 03 / Maxim en tissu Fabia c/03  
Máxim página izquierda en Fabia 17  
Maxim in Fabia 17 / Maxim en fabia 17



Maxim en Fabia 13  
Maxim in fabia 13 / Maxim en tissu Fabia 13

## Maxim

El modelo Maxim se amolda a la perfección a gustos sofisticados no solamente por la enorme comodidad de su sentada, sino por la suave, original y atractiva forma de sus brazos, que armoniza a la perfección con el diseño de su respaldo, que separa con elegancia la espalda de la parte de la cabeza.

The model Maxim is a perfect answer to sophisticated pleasures not only for the comfort it provides but also for the smooth, original and attractive form of its armrest that match perfection with the design of its back that separate back and head.

Le modèle Maxim répond à la perfection aux goûts sophistiqués, pas seulement pour son confort mais plutôt pour son tact doux, original et attractif de ses accoudoirs qui sont en parfaite harmonie avec son dossier qui sépare avec élégance le dos et la tête.



Maxim en Fabia 18  
Maxim in Fabia 18 / Maxim in fabia 18











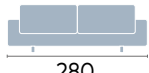
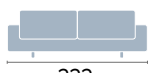
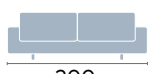





Maxim en Fabia 18  
Maxim in Fabia 18 / Maxim in fabia 18

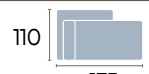

# Maxim

# Maxim

Tarifa por puntos/rate/tarif	medidas / measurements / mesures			Series telas / Fabrics series / Série de tissus							Series piel / Leather series / Série cuir				Metroaje	Nº Decorativos	Cubicaje M <sup>3</sup>
	Largo	Fondo	Altura	G/0	G/1	G/2	G/3	G/4	T Cliente	Piel 1	Piel 2	Piel 3	Piel 4				
100  280	Maxim 3 pl	280	102	100	800	840	880	933	989	760	1000	1060	1166	1283	15,5	2 DECO 50*50	2,55
 222	Maxim 3 pl	222	102	100	605	628	660	700	742	569	813	849	934	1027	12,5	2 DECO 50*50	2,01
 200	Maxim 3 pl	200	102	100	592	614	646	685	726	556	804	840	924	1016	12,4	2 DECO 50*50	1,82
 180	Maxim 2 pl	180	102	100	583	605	637	675	716	546	794	830	913	1004	11,3	2 DECO 50*50	1,64
 117	Maxim 1 pl	117	102	100	335	343	361	383	406	317	451	461	507	558	6,5	2 DECO 50*50	1,06
 140	Maxim 1 pl 1/b	140	102	100	400	420	440	466	494	380	500	530	583	641	7,3	1 DECO 50*50	1,27
 111	Maxim 1 pl 1/b	111	102	100	304	315	330	350	371	285	407	425	468	515	6	1 DECO 50*50	1,01
 100	Maxim 1 pl 1/b	100	102	100	297	307	323	342	363	279	402	420	462	508	6,25	1 DECO 50*50	0,91
 90	Maxim 1 pl 1/b	90	102	100	291	303	319	338	358	273	397	415	457	503	6,1	1 DECO 50*50	0,82
 114	Maxim 1 pl s/b	114	102	100	410	422	437	463	491	392	496	522	574	631	6,5	-	1,03
 85	Maxim 1 pl s/b	85	102	100	285	297	312	331	351	267	371	397	437	481	5	-	0,77
 74	Maxim 1 pl s/b	74	102	100	279	289	305	323	342	261	375	384	422	464	4,3	-	0,67
 64	Maxim 1 pl s/b	64	102	100	273	298	301	319	338	255	371	389	428	471	3,8	-	0,58
110  175	Maxim tumbona arcón 1,10 * 1,75	110	175	100	271	295	325	345	366	253	497	515	567	624	8,9	2 DECO 50*50	1,72
100  175	Maxim tumbona arcón 1,00 * 1,75	100	175	100	262	285	316	335	355	244	487	505	556	612	8,6	2 DECO 50*50	1,56
140  160	Maxim tumbona 1,40 * 1,60	140	160	100	399	410	425	451	478	380	502	520	572	629	12,5	2 DECO 50*50	1,99
110  110	Maxim mod. Rincón.	110	110	100	340	360	380	403	427	310	590	619	681	749	7,5	-	1,08



Maxim en Fabia 8  
Maxim in Fabia 08 / Maxim en Fabia 08

## Características técnicas / Technical characteristics / Caractéristiques techniques

- ESTRUCTURA: MADERA DE PINO
- RECUBRIMIENTO: ESPUMA DE POLIURETANO DE 1,5 CM
- ALMOHADONES ASIENTO: ASIENTO HR 32 KG. CON VISCOELÁSTICA
- ALMOHADONES RESPALDO: SUPER SUAVE 22 KG
- COJINES ASIENTO: RELAX MOTORIZADO (FIJO SIN RELAX , DTO. 52 PUNTOS)
- RESPALDO: ABATIBLE
- PATAS: METÁLICAS.
- ESTE MODELO, SIEMPRE QUE VAYA TAPIZADO EN PIEL, NO INCLUIRÁ DECORATIVOS DE SERIE EN NINGUNA DE SUS MODULACIONES.
- SE PUEDEN REDUCIR LOS BRAZOS DEL MODELO EN 5 CM SIN INCREMENTO EN LA TARIFA , A EXCEPCIÓN DE LOS BRAZOS DE LAS DIFERENTES TUMBONAS QUE NO ADMITIRÁN REDUCCIÓN.
- OPCIÓN CABEZAL ELECTRICO; INCREMENTO DE 40 PUNTOS POR MODULO CON CABEZAL MOTORIZADO.
- CABEZALES DE 114 CM Y 140 CM INCREMENTO DE 60 PUNTOS, SE COBRAN 40 PUNTOS PARA RESTO DE CABEZALES.
- EN EL MODULO TUMBONA SOLO DISPONIBLE OPCIÓN CABEZAL MANUAL.
- ESTE MODELO NO PODRÁ LLEVAR ARCON EN EL ASIENTO DE LA TUMBONA O CHAISLONGUE
- STRUCTURE: BOIS DE PIN
- RECOUVREMENT: COUCHE DE MOUSSE DE POLYURÉTHANE 1.5 CM
- ALMOHADONES ASIENTO: ASIENTO HR 32 KG AVEC SURPLOMBÉE DE VISCOELASTIQUE
- COUSSIN D'ASSISE: MOUSSE HR 32 KG AVEC SURPLOMBÉE DE VISCOELASTIQUE
- COUSSIN DE DOSSIER: MOUSSE SUPER DOUCE 22 KG
- ASSISE MOTORISÉE (RELAX). FIXE (SANS MOTEUR) REMISE DE 52 POINTS
- DOSSIER RECLINABLE
- PIÈTEMENT MÉTALLIQUE
- THERE IS NO PILLOWS INCLUDED IN THIS MODEL WHEN MADE IN LEATHER
- 5 CM CAN BE REDUCED IN THE WIDTH OF ARMRES WITHOUT COST EXCEPT ON CHAISLONGS.
- THERE ARE ADDITIONNAL FEES FOR ELECTRIC.
- HEADRESTS.THOSE ARE 60 POINTS FOR HEADREST OF 114 AND 140 , AND THE REST OF DIMENSIONS IS 40 POINTS.
- IN THIS MODEL THERE IS NO POSSIBILITY TO MAKE THE CHAISLONG WITH CHEST BELOW THE SEAT
- STRUCTURE: PINE WOOD
- RECOVERY: LAYER OF POLYURETHANE FOAM 1.5 CM
- SEAT CUSHION: HR FOAM 32 KG WITH A LAYER OF VISCOELASTIC ON TOP
- BACK CUSHION: EXTRA SMOOTH FOAM 22 KG
- MOTORIZED SEAT (RELAX). WITHOUT ENGINE , 52 POINTS LESS.
- RECLINABLE HEADREST
- LEGS: METAL
- CE MODELE EN CUIR N'INCLUT PAS DE DECOS
- LES ACCOUDOIRS DE CE MODELE PEUVENT ETRE REDUITS DE 5 CM, PAS PLUS .C'EST IMPOSSIBLE SUR LES CHAISLONGUES.
- LES TÊTIÈRES ELECTRIQUES ENTRAINES UN SUPPLEMENT DE 60 POINTS POUR LES DIMENSIONS 114 ET 140, POUR LE RESTE C'EST 40 POINTS.
- IL N'EST PAS POSSIBLE DE FAIRE LA CHAISLONGUE DE CE MODELE AVEC COFFRE.



**DVN**<sup>®</sup>  
S T A R  
La marca que mejor te sienta



# Big Confort

Big Confort en Rado 4  
Big confort in rado 04 / Big confort en rado 04  
Big Confort pág. izquierda en Rado 16  
Big confort in rado 16 / Big confort en rado 16



Big Confort en Rado 8  
*Big confort in rado 08 / Big confort en rado 08*



Big Confort en Rado 11  
*Big confort en rado 11 / Big confort in rado 11*

## Big confort

Big confort es un sofá de diseño innovador, único en si género. Ideal para ambientes de estilo urbano, modernos y dinámicos. Sus sistema de relax lo convierte en extremadamente práctico para los momentos de descanso.

Big confort is an innovator couch exclusive in relax couch sector for environments of urban style modern and dynamic. Alaska's relax system is perfect for relax time.

Big confort est un canapé de dessin innovateur, unique dans son genre, idéal pour des climats, modernes et dynamiques de style urbain. Son système relax est parfait pour les moments de repos.



Big Confort en Rado 6  
Big confort in rado 06 / Big confort en rado 06

## Big Confort



# Big Confort

Tarifa por puntos/rate/tarif	medidas / measurements / mesures	Series telas / Fabrics series / Série de tissus									Series piel / Leather series / Série cuir				Metroje	Nº Decorativos	Cubicaje M <sup>3</sup>
		Largo	Fondo	Altura	G/0	G/1	G/2	G/3	G/4	T Cliente	Piel 1	Piel 2	Piel 3	Piel 4			
92  228	Big confort 3 pl a 2,28 (x) (b1+b1)	228	102	105	605	628	660	700	742	569	813	849	934	1027	13,4	2 DECO 50*50	2,34
208	Big confort 3 pl a 2,08 (x) (b2+b2)	208	102	105	592	614	646	685	726	556	804	840	924	1016	13,2	-	2,07
182	Big confort 2 pl (x) (b3+b3)	182	102	105	583	605	637	675	716	546	794	830	913	1004	12,3	-	1,87
124	Big confort 1 pl (x)	124	102	105	335	343	361	383	406	317	451	461	507	558	6,3	-	1,22
114	Big confort mod. 1 Pl a 1,11 (x) (b1) 1/b	114	102	105	304	315	330	350	371	285	407	425	468	515	7,2	-	1,17
101	Big confort mod. 1 Pl a 1,01 (x) (b2) 1/b	101	102	105	297	307	323	342	363	279	402	420	462	508	6,8	-	1,04
94	Big confort mod. 1 Pl a 0,91 (x) (b3) 1/b	94	102	105	291	303	319	338	358	273	397	415	457	503	6,2	-	0,93
84	Big confort mod. 1 Pl a 0,84 (x) (b4) s/b	84	102	105	285	297	312	331	351	267	371	397	437	481	4,8	-	0,86
76	Big confort mod. 1 Pl a 0,74 (x) (b5) s/b	74	102	105	279	289	305	323	342	261	375	384	422	464	4,5	-	0,76
64	Big confort mod. 1 Pl a 0,64 (x) (b6) s/b	64	102	105	273	280	301	319	338	255	361	389	428	471	4,3	-	0,66
115  175	Big confort chaiselón mv1 1,15*1,75	115	175	105	271	295	325	345	366	253	497	515	567	624	10,8	2 DECO 50*50	1,18
105  175	Big confort chaiselón mv1 1,05*1,75	105	175	105	262	285	316	335	355	244	487	505	556	612	10,8	2 DECO 50*50	1,08
110  175	Big confort tumbona 1,10*1,75 (b7)	110	175	105	271	295	325	345	366	253	497	515	567	624	11	2 DECO 50*50	1,94
100  175	Big confort tumbona 1,00*1,75 (b8)	100	175	105	262	285	316	335	355	244	487	505	556	612	11	2 DECO 50*50	1,77
110  110	Big confort mod. Rincón	110	110	105	340	360	380	403	427	310	590	619	681	749	8	-	1,22



Big Confort en Rado 8  
Big confort in rado 08 / Big confort en rado 08



## Características técnicas / Technical characteristics / Caractéristiques techniques

- ESTRUCTURA: MADERA DE PINO Y PARTÍCULAS.
- ALMOHADAS ASIENTOS: ASIENTO HR 30 KG CON FIBRA DE 400 GR.
- ALMOHADAS RESPALDO: FIBRA ALTA RESISTENCIA "OPTIFIBRE".
- COJINES DE ASIENTO: RELAX ELECTRICO MOTORIZADO (FIJO SIN RELAX SE DESCUENTA 52 PUNTOS).
- PATAS DELANTERAS METÁLICAS . TRASERAS PVC (patas plástico).
- ESTE MODELO, SIEMPRE QUE VAYA TAPIZADO EN PIEL, NO INCLUIRÁ DECORATIVOS DE SERIE EN NINGUNA DE SUS MODULACIONES. SE PUEDEN REDUCIR LOS BRAZOS DEL MODELO EN 5 CM SIN INCREMENTO EN LA TARIFA , A EXCEPCIÓN DE LOS BRAZOS DE LOS DIFERENTES CHAISLONGUES Y TUMBNAS DEL MISMO QUE NO ADMITIRAN REDUCCIÓN.

- STRUCTURE PINE WOOD AND WOOD PARTICLES.
- SEAT CUSHION HR FOAM 30 KG WITH 400 GR FIBER ON TOP.
- BACK CUSHION HIGH RESISTANCE FIBER "OPTIFIBRE".
- SEAT WITH MOTORIZED RELAX (WITHOUT RELAX , 52 POINTS LESS).
- LEGS FRONT METAL , BACK PVC (PLASTIC).
- THERE IS NO PILLOW INCLUDED IN THIS MODELE WHEN MADE IN LEATHER.
- ARMRESTS CAN BE MADE 5 CM LESS WIDE WITHOUT COST ,EXCEPT ON CHAISLONGES,

- STRUCTURE BOIS DE PIN ET PARTICULES DE BOIS.
- COUSSIN D'ASSISE MOUSSE HR 30 KG AVEC 400 GR DE FIBRE SUR LA PARTIE SUPÉRIEUR.
- COUSSIN DOSSIER FIBRE HAUTE RÉSTANCE "OPTIFIBRE".
- ASSISE AVEC RELAX MOTORISÉ (FIXE SANS RELAX , 52 POINTS DE MOINS).
- PIÈTEMENT AVANT MÉTALLIQUE , ARRIÈRE PVC (PLASTIQUE).
- CE MODELE EMCUIR N'INCLUT PAS DE COUSSINS DECO.
- LES ACCOUDOIRS DE CE MODELE PEUVENT ETRE REDUITS DE 05 CM EXCEPTÉ SUR LES CHAISLONGUES.

**DVNI**<sup>®</sup>  
S T A R

La marca que mejor te sienta





**DVN**<sup>®</sup>  
S T A R  
La marca que mejor te sienta



# Eiffel

Eiffel en Thalys 15 y 19  
Eiffel in thalys 15 and 19 / Eiffel en thalys 15 et 19  
Eiffel página izquierda en Thalys 19, 03, 07, 19, 03 y 01  
Eiffel in thalys 19,03,07,19,03 and 01 / Eiffel en thalys 19,03,07,19,03 et 01



# Eiffel



Eiffel en Thalys 09, 08, 07, 06, 07 y 09  
Eiffel in thalys 09, 08, 07, 06, 07 and 09 / Eiffel en thalys 09, 08, 07, 06, 07 et 09



Eiffel en Thalys 16, 10, 14, 08, 16 y 08  
Eiffel in thalys 16,10,14,08,16 and 08 / Eiffel en thalys 16, 10,14,08,16 et 08  
Eiffel página derecha en Thalys 06, 08, 05, 08, 06 y 07  
Eiffel in thalys 06, 08,05,08 , 06 and 07 / Eiffel en thalys 06,08,05,08,06 et 07

## Eiffel

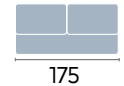
# Eiffel

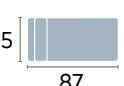
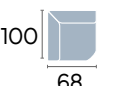
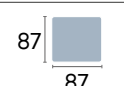
Tarifa por puntos/rate/tarif	medidas / measurements / mesures	Series telas / Fabrics series / Série de tissus									Metraje	Nº Decorativos	Cubicaje M³
		Largo	Fondo	Altura	G/0	G/1	G/2	G/3	G/4	T Cliente			
90 	Eiffel mod. 1,75 S/b	175	65	90	360	380	400	424	449	342	6,5	-	1,02
	Eiffel mod. 0,87 S/b	87	65	90	240	260	285	302	320	228	3,5	-	0,51
65 	Eiffel chaiselón	87	65	90	360	380	400	424	449	342	5,5	-	0,51
100 	Eiffel mod. Rincón	100	68	90	350	370	390	413	438	333	5,2	-	0,61
87 	Eiffel pouff 0,87*0,87	87	87	48	160	180	200	212	225	152	3,2	-	0,36



Eiffel en Thalys 17, 07, 19 y 15  
Eiffel in thalys 17,07,19 and 15 / Eiffel en thalys 17,07,19 et 15

## Características técnicas / Technical characteristics / Caractéristiques techniques

- ESTRUCTURA: MADERA DE PINO MACIZO COMBINADO CON PARTICULAS DE AGLOMERADO DE 18 mm.
- RECUBRIMIENTO: NAPA SINTETICA DE POLIESTER DE 300 gr.
- ALMOHADAS ASIENTOS Y RESPALDOS: ESPUMA DE POLIURETANO DE 30 Kg SR COMBINADA CON ESPUMA DE 24 Kg PIUMEX.
- PATAS: PLASTICO DE 5 CM
- STRUCTURE: SOLID PINWOOD WITH WOOD PARTICLES OF 18 MM
- RECOVERY: SYNTHETIC MATERIAL DERIVED FROM POLYESTER 300 G
- LEGS: PLASTIC LEGS OF 5 CM HIGH
- STRUCTURE: BOIS DE PIN MASSIF COMBINÉ A DU BOIS DE PARTICULES DE 18 MM.
- RECOUVREMENT: MATÉRIEL SYNTHÉTIQUE DE POLIESTER DE 300 G.
- ASSISES ET DOSSIERS: MOUSSE DE POLYURÉTHANE DE 30 KG SR
- CAMBINÉE A UNE MOUSSE DE 24 MARQUE PIUMEX. PIÈTEMENT: PIEDS EN PLASTIC DE 5 CM.





**DVN**<sup>®</sup>  
S T A R  
La marca que mejor te sienta



# América

América en piel Maximum Marrón  
America in Brown Maximus leather / Fauteuil America en cuir maximus marron



1. América en piel Módena Mostarda - 2. América en piel Módena Foresta - 3. América en piel Módena Rosso - 4. América en piel Módena Rosso  
1. America chair in leather modena mostarda - 2. America in leather modena foresta - 3. America in leather modena rosso - 4. America in leather modena turquoise  
1. Fauteuil america en cuir modena mostarda - 2. Fauteuil america en cuir modena foresta - 3. Fauteuil america em cuir modena rosso - 4. Fauteuil america en cuir modena turquoise

## América



América, un sillón espectacular, ergonómico y muy atractivo. Su estilizado diseño juega con líneas curvas perfectamente armonizadas. Dinamismo visual que le confiere vanguardia y personalidad.

América is a spectacular armchair, ergonomic and attractive. Its stylized design plays with curve lines perfectly harmonized. Visual dynamism that gives you vanguard and personality.

Amérique, un fauteuil spectaculaire, ergonomique et très attractif. Son dessin stylisé joue avec des lignes courbes parfaitement harmonisées. Dynamisme visuel qui confère une avant-garde et une personnalité.



# América

Tarifa por puntos/rate/tarif	medidas / measurements / mesures			Series telas / Fabrics series / Série de tissus					Series piel / Leather series / Série cuir				Metroje	Cubiçaje M <sup>3</sup>		
	Largo	Fondo	Altura	G/0	G/1	G/2	G/3	G/4	T Cliente	Piel 1	Piel 2	Piel 3			Piel 4	
100 	América BUTACA	75	85	100	277	314	351	372	394	245	475	540	594	653	6	0,60
45 	América PUB redondo o cuadrado	40	40	45	150	160	170	187	206	140	180	190	209	230	1,2	0,10

\* Se puede hacer en un combinado de piel y microfibra bajo petición de presupuesto

\* It can be combining leather and fabric but before ask for budget

\* Ce fauteuil peut être fabriqué dans une combinaison de cuir et de tissu mais dans ce cas il faudrait demander un devis

## Opciones de pata / Leg options / Options de pied

• PATA MADERA DE FRENSO NATURAL EN ASPA, INCREMENTO 55 PUNTOS.  
• PATA DE MADERA DE FRENSO NATURAL CIRCULAR INCREMENTO DE 30 PUNTOS.

• PRICE OF LEGS MADE OF CHROMED BLADE AND NATURAL ASHWOOD 55 PTS.  
• PRICE OF ROUND CHROMED LEGS WRAPPED IN NATURAL ASHWOOD 30 PTS

• LE PIETEMENT PIED POULE EN CHROME ET BOIS DE FRÊNE ENTRAINE UN SUPPLEMENT DE 55 PTS.  
• LE PIETEMENT CIRCULAIRE EN CHROME ET BOIS DE FRÊNE ENTRAINE UN SUPPLEMENT DE 30 PTS



1. América en piel Módena Bianco - 2. América en piel Módena Terracota

1. America , leather modena bianco - 2. America cuir modena bianco / 1. America leather modena terracota - 2. America en cuir modena terracota

## Características técnicas butaca

/ Technical characteristics chair / Caractéristiques techniques fauteuil

• ESTRUCTURA: MADERA DE PINO MACIZO, BRAZO 10 CM  
• RECUBRIMIENTO: ESPUMA DE POLIURETANO DE 25 KG  
• BRAZOS: MADERA DE PARTÍCULAS  
• PATAS: METALICA GIRATORIA

• STRUCTURE: BOIS DU PIN 10 CM  
• RECOUVREMENT: MOUSSE DE POLYURÉTHANDE DE 25 KG.  
• BRAS: BOIS DE PARTICULES  
• PIEDS: MÉTALLIQUES TOURNANTS

• STRUCTURE: PINE WOOD  
• COVERING: POLYURETHANE FOAM OF 25 KG.  
• ARMS: PARTICLE WOOD.  
• LEGS: METALLIC, ROTARY

## Características técnicas pouff

/ Technical characteristics pouff / Caractéristiques techniques pouff

• ESTRUCTURA: MADERA DE PINO MACIZO  
• RECUBRIMIENTO: ESPUMA DE POLIURETANO DE 25 KG  
• PATAS: METALICA GIRATORIA

• STRUCTURE: BOIS EN PIN  
• RECOUVREMENT: MOUSSE DE POLYURÉTHANDE 25 KG  
• PIEDS: MÉTALLIQUES TOURNANTS

• STRUCTURE: PINE WOOD  
• COVERING: POLYURETHANE FOAM OF 25 KG.  
• LEGS: METALLIC, ROTARY

## Opciones de pata

/ Leg options / Options de pied



+30



+55



1. América en piel Módena Nero - 2. América en piel Módena Tortora - 3. América en piel Módena 2020 / 2021 - 4. América en piel Módena Granato  
1. America , leather modena nero - 2. America in leather modena tortora - 3. America leather modena 2020/2021 - 4. America , leather modena deep-red  
1. America en cuir modena nero - 2. America en cuir modena tortora - 3. America en cuir modena 2020/2021 - 4. America en cuir modena rouge bordeaux



**DVN**<sup>®</sup>  
**S T A R**  
La marca que mejor te sienta

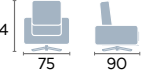

# Laren

Tarifa por puntos/rate/tarif	medidas / measurements / mesures			Series telas / Fabrics series / Série de tissus					Metraje	Nº Decorativos	Cubioaje M <sup>3</sup>	
	Largo	Fondo	Altura	G/0	G/1	G/2	G/3	G/4				T Cliente
114  BUTACA MOTORIZADA	75	90	114	375	400	425	451	478	325	5	-	0,80

## Características técnicas / Technical characteristics / Caractéristiques techniques

- ESTRUCTURA: MADERA DE PINO MACIDO.
- RECUBRIMIENTO: ESPUMA DE POLIURETANO DE 25 KG.
- RESPALDOS Y ASIENTOS: GOMA 30 KG
- PATAS: METÁLICA GIRATORIA
- STRUCTURE : MASSIVE PINE WOOD.
- RECOVERY: LAYER OF POLYURETHANE 25 KG.
- SEAT AND BACK CUSHION: FOAM 33 KG
- LEGS: ROTARY METALLIC LEG
- STRUCTURE BOIS DE PIN MASSIF.
- RECOUVREMENT COUCHE DE POLYURÉTHANE 25 KG.
- COUSSIN D'ASSIDE ET DOSSIER: MOUSSE 30 KG
- PIÈTEMENT: PIEDS METALLIQUE ROTATIF.



**Laren**

Butaca Laren en Ascot Pearl  
Loren chair in Ascot pearl / Fauteuil Loren en Ascot pearl

# Luigi

Tarifa por puntos/rate/tarif	medidas / measurements / mesures			Series telas / Fabrics series / Série de tissus					Series piel / Leather series / Série cuir				Metroje	Nº Decorativos	Cubiçaje M <sup>3</sup>	
	Largo	Fondo	Altura	G/0	G/1	G/2	G/3	G/4	T Cliente	Piel 1	Piel 2	Piel 3				Piel 4
100  Luigi butaca 1 pl	90	85	100	325	348	371	393	417	308	463	510	561	617	5,5	-	



## Características técnicas butaca / Technical characteristics / Caractéristiques techniques





- ESTRUCTURA: MADERA DE PINO MACIZA Y PARTÍCULAS DE AGLOMERADO DE 18 MM.
- RECUBRIMIENTO: ESPUMA DE POLIURETANO DE 1,5 CM , DE 20 KG.
- ALMOHADÓN ASIENTO: ESPUMA DE POLIURETANO DE 30 KG SUAVE , RECUBIERTO CON NAPA DE 300 GR.
- ALMOHADÓN RESPALDO: ESPUMA DE POLIURETANO DE 20 KG SUAVE , RECUBIERTO CON NAPA DE 300 GR.
- PATA: METÁLICA Y GIRATORIA.
- STRUCTURE: SOLID PINWOOD AND WOOD PARTICLES OF 18 MM
- RECOVERY: POLYURETHANE FOAM OF 30 KG , SMOOTH , COVERED WITH NAPPA OF 300 G
- SEAT CUSHION: POLYURETHANE FOAM OF 30 KG , SMOOTH , COVERED WITH NAPPA OF 300 G
- BACK CUSHION: POLYURETHANE FOAM OF 20 KG , SMOOTH , COVERED WITH NAPPA OF 300 G
- LEGS: ROTATING METALLIC LEG
- STRUCTURE: BOIS DE PIN MASSIF ET PARTICULES DE BOIS DE 18 MM
- RECOUVREMENT: MOUSSE DE POLYURÉTHANE DE 1,5 CM (20KG)
- COUSSIN D'ASSISE: MOUSSE DE POLYURÉTHANE DE 30 KG , MOELLEUSE , RECOUVERTE DE NAPPA DE 300 G
- COUSSIN DE DOSSIER: MOUSSE DE POLYURÉTHANE DE 20 KG , MOELLEUSE , RECOUVERTE DE NAPPA DE 300 G
- PIÈTEMENT: PIED METALLIQUE ROTATIF



# Luigi

1. Butaca Luigi en piel Módena Tortora y Evice O4 - 2. Butaca Luigi en piel Módena Foresta y Evice O2  
 1. Luigi chair made in modena tortora leather and evice O4 fabric - 2. Luigi chair made in modena foresta leather and evice O2 fabric  
 1. Fauteuil Luigi en cuir modena tortora et en tissu Evice O4 - 2. Fauteuil Luigi en cuir modena foresta et en tissu Evice O2  
 Butaca Luigi página izquierda en piel Módena Mostarda y Evice 14  
 Luigi chair made in modena mostarda leather and Evice 14 / Fauteuil Luigi en cuir modena mostarda et en tissu Evice 14

# Taycan

Tarifa por puntos/rate/tarif	medidas / measurements / mesures			Series telas / Fabrics series / Série de tissus							Series piel / Leather series / Série cuir				Metroje	Cubiçaje M <sup>3</sup>
	Largo	Fondo	Altura	G/0	G/1	G/2	G/3	G/4	T Cliente	Piel 1	Piel 2	Piel 3	Piel 4			
120   Taycan Butaca 1 pl eléctrica	85	73	120	600	630	661	693	727	580	695	729	773	819	5,5	0,75	
120   Taycan Butaca 1 pl manual	85	73	120	480	510	541	573	607	460	575	609	653	699	5,5	0,75	

## Características técnicas / Technical characteristics / Caractéristiques techniques

- ESTRUCTURA: ARMAZON MECANISMO METÁLICO, COMBINADO LOS BRAZOS EN DM 18 MM Y MADERA DE PINO.
- RECUBRIMIENTO: ESPUMAS DE POLIURETANO COMBINADO CON FLOCA DE 300 GR.
- ALMOHADAS ASIENTOS: BLOQUE DE ESPUMA DE 30 KG SR COMBINADO CON FLOCA DE 300 GR.
- ALMOHADAS RESPALDO: BLOQUE DE ESPUMA DE 20 KG SS. COMBINADO CON FLOCA DE 300 GR.
- SILLÓN RELAX
- PATAS: METÁLICAS
- STRUCTURE: METALLIC FRAMEWORK WITH ARMREST MADE IN A MIXTURE OF DM 18 MM AND PINE WOOD
- RECOVERY: LAYER OF POLYURETHANE FOAM COMBINED WITH 300 GR OF COMPACTED FIBRE
- SEAT CUSHION: BLOCK OF FAOM OF 30 KG COMBINED WITH 300 GR OF COMPACTED FIBRE
- BACK CUSHION: BLOCK OF FAOM OF 20 KG COMBINED WITH 300 GR OF COMPACTED FIBRE
- SEAT: ELECTRIC RELAX
- LEGS: METAL
- STRUCTURE: ARMATURE MÉTALLIQUE AVEC ACCOUDOIRS EN DM 18 MM ET BOIS DE PIN
- RECOUVREMENT: COUCHE DE POLYURETHANE COMBINÉE A 300 GR DE FIBRE COMPACTÉE
- COUSSIN D'ASSISE: BLOCK DE MOUSSE DE 30 KG COMBINÉE AVEC 300 GR DE FIBRE COMPACTÉE
- COUSSIN DE DOSSIER: BLOCK DE MOUSSE DE 20 KG COMBINÉE AVEC 300 GR DE FIBRE COMPACTÉE
- ASSISE: RELAX MOTORISÉ
- PIÈTEMENT: MÉTALLIQUE







# Taycan

1. Butaca Taycan en piel Módena Tortora - 2. Butaca Taycan en piel Módena Capuccino  
1. Fauteuil Taycan en cuir modena tortora - 2. Fauteuil Taycan en cuir modena capuccino  
Butaca Taycan página izquierda en piel Módena Terracota  
Taycan chair in leather modena terracota / Fauteuil Taycan en cuir modena terracota

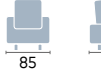

# Rosalía

Tarifa por puntos/rate/tarif	medidas / measurements / mesures			Series telas / Fabrics series / Série de tissus							Series piel / Leather series / Série cuir				Metroje	Nº Decorativos	Cubicoje M <sup>2</sup>
	Largo	Fondo	Altura	G/0	G/1	G/2	G/3	G/4	T Cliente	Piel 1	Piel 2	Piel 3	Piel 4				
120  	Rosalía Butaca 1 pl motor	85	73	120	600	630	661	693	727	580	695	729	773	819	5,5	-	0,60
120  	Rosalía Butaca 1 pl manual	85	73	120	480	510	541	573	607	460	575	609	653	699	5,5	-	0,60



## Características técnicas / Technical characteristics / Caractéristiques techniques

- ESTRUCTURA: ARMAZON MECANISMO METÁLICO, COMBINADO LOS BRAZOS EN DM 18 MM Y MADERA DE PINO.
- RECUBRIMIENTO: ESPUMAS DE POLIURETANO COMBINADO CON FLOCA DE 300 GR
- ALMOHADAS ASIENTOS: BLOQUE DE ESPUMA DE 30 KG SR COMBINADO CON FLOCA DE 300 GR.
- ALMOHADAS RESPALDO: BLOQUE DE ESPUMA DE 20 KG SS. COMBINADO CON FLOCA DE 300 GR.
- COJÍN ASIENTO: RELAX MOTORIZADO
- PATAS: METÁLICAS
- STRUCTURE: METALLIC FRAMEWORK COMBINED WITH ARMREST IN DM 18 MM AND PINE WOOD
- RECOVERY: POLYURETHANE FOAM WITH 300 GR OF COMPACTED FIBER
- SEAT CUSHION: BLOCK OF FOAM 30 KG COMBINED WITH 300 GR OF COMPACTED FIBRE
- BACK CUSHION: BLOCK OF FOAM OF 20 KG COMBINED WITH 300 GR OF COMPACTED FIBRE
- SEAT: ELECTRIC RELAX
- LEGS: METAL
- STRUCTURE: ARMATURE MÉTALLIQUE AVEC ACCOUDOIR EN DM DE 18 MM ET BOIS DE PIN
- RECOUVREMENT: COUCHE DE MOUSSE POLYURÉTHANE AVEC 300 GR DE FIBRE COMPACTÉE
- COUSSIN D'ASSISE: BLOCK DE MOUSSE POLYURÉTHANE AVEC 300 GR DE FIBRE COMPACTÉE
- COUSSIN DE DOSSIER: BLOCK DE MOUSSE DE 20 KG COMBINÉ AVEC 300GR DE FIBRE COMPACTÉE
- ASSISE: RELAX MOTORISÉ
- PIÈTEMENT: MÉTALLIQUE



# Rosalía

# Leonor

Tarifa por puntos/rate/tarif	medidas / measurements / mesures			Series telas / Fabrics series / Série de tissus					Series piel / Leather series / Série cuir				Metroje	Nº Decorativos	Cubiçoje M <sup>2</sup>	
	Largo	Fondo	Altura	G/0	G/1	G/2	G/3	G/4	T Cliente	Piel 1	Piel 2	Piel 3				Piel 4
120  Leonor Sillón 1 pl motor	85	73	120	600	630	661	701	743	580	695	729	773	819	5,5	-	0,60
120  Leonor Sillón 1 pl manual	85	73	120	480	510	541	573	607	460	575	609	653	699	5,5	-	0,60

## Características técnicas / Technical characteristics / Caractéristiques techniques



- ESTRUCTURA: ARMAZON MECANISMO METÁLICO, COMBINADO LOS BRAZOS EN DM 18 MM Y MADERA DE PINO.
- RECUBRIMIENTO: ESPUMAS DE POLIURETANO COMBINADO CON FLOCA DE 300 GR
- ALMOHADAS ASIENTOS: BLOQUE DE ESPUMA DE 30 KG SR COMBINADO CON FLOCA DE 300 GR.
- ALMOHADAS RESPALDO: BLOQUE DE ESPUMA DE 20 KG SS. COMBINADO CON FLOCA DE 300 GR.
- COJÍN ASIENTO: RELAX MOTORIZADO
- PATAS: METÁLICAS
- STRUCTURE: METALLIC FRAMEWORK WITH WOODEN ARMREST MADE IN DM AND PINE WOOD
- RECOVERY: POLYURETHANE FOAM COMBINED WITH 300 GR OF COMPACTED FIBRE
- SEAT CUSHION: BLOCK OF FOAM OF 30 KG COMBINED WITH 300 GR OF COMPACTED FIBRE
- BACK CUSHION: BLOCK OF FOAM OF 20 KG COMBINED WITH 300 GR OF COMPACTED FIBRE
- SEAT: ELECTRIC RELAX
- LEGS: METAL
- STRUCTURE: ARMATURE METALLIQUE AVEC ACCOUDOIR EN DM ET BOIS DE PIN
- RECOUVREMENT: COUCHE DE MOUSSE POLYURETHANE COMBINÉE AVEC 300 GR DE FIBRE COMPACTÉE
- COUSSIN D'ASSISE: BLOCK DE MOUSSE POLYURÉTHANE DE 30 KG COMBINÉE AVEC 300 GR DE FIBRÉ COMPACTÉE
- COUSSIN DE DOSSIER: BLOCK DE MOUSSE DE 20 KG COMBINÉE A 300 GR DE FIBRE COMPACTÉE
- ASSISE: RELAX MOTORISÉ
- PIÈTEMENT: MÉTALLIQUE



# Leonor



## Pradas

Tarifa por puntos/rate/tarif	medidas / measurements / mesures			Series telas / Fabrics series / Série de tissus							Metraje	Nº Decorativos	Cubiçaje M³
	Largo	Fondo	Altura	G/0	G/1	G/2	G/3	G/4	T Cliente				
88  78  105	Pradas 1PI	76	105	88	362	401	436	463	491	344	6,8	-	0,61



1. Izquierda Pradas en Velvet Lin 71 - 2. Pradas en Velvet Lin 77 - 3. Pradas en Velvet Lin 73 - 4. Pradas en Velvet Lin 34  
Pradas chair 1 in velvet lin 71, 2 in velvet lin 77, 3 in velvet lin 73, 4 in velvet lin 34 / Fauteuil Pradas 1 en velvet lin 71, 2 en velvet lin 77, 3 en velvet lin 73, 4 en velvet lin 34

### Características técnicas / Technical characteristics / Caractéristiques techniques

- ESTRUCTURA: MADERA DE PINO Y PARTÍCULAS
- RECUBRIMIENTO: ESPUMA DE POLIURETANO DE 1,5 CM
- ALMOHADAS ASIENTOS: BULFLEX
- ALMOHADAS RESPALDO: FIBRA DE MICROFIBRA TACTO PLUMA
- PATAS: METÁLICAS

- STRUCTURE :PINE WOOD AND WOOD PARTICLES
- RECOVERY :LAYER OF POLYURETHANE FOAM OF 1.5 CM
- SEAT CUSHION: BULFLEX
- BACK CUSHION: FIBER OF MICROFIBER FEATHER TOUCH
- LEGS :METAL

- STRUCTURE :BOIS DE PIN ET BOIS DE PARTICULES
- RECOUVREMENT :COUCHE DE MOUSSE POLYURÉTHANE DE 1.5 CM
- COUSSIN D'ASSISE : BULFLEX
- COUSSIN DE DOSSIER: FIBRE DE MICROFIBRE SENSATION PLUME
- PIÈTEMENT: MÉTALLIQUE

# Pradas





**DVN**  
S T A R  
La marca que mejor te sienta



# Nube

# Nube

Tarifa por puntos/rate/tarif	medidas / measurements / mesures			Series telos / Fabrics series / Série de tissus					Series piel / Leather series / Série cuir				Metroaje	Nº Decorativos	Cubiçaje M <sup>3</sup>	
	Largo	Fondo	Altura	G/0	G/1	G/2	G/3	G/4	T Cliente	Piel 1	Piel 2	Piel 3				Piel 4
75  Bube Sillón 1 pl	75	90	75	250	275	300	318	337	233	400	420	462	508	3,8	-	0,50



1. Butaca Nube en Dolxe 3005 - 2. Butaca Nube en Dolxe 3006 - 3. Butaca Nube en Dolxe 3005  
 1. Nube chair in dolxe 3005 - 2. Nube chair in dolxe 3006 - 3. Nube chair in dolxe 3005  
 1. Fauteuil nube en dolxe 3005 - 2. Fauteuil Nube en dolxe 3006 - 3. Fauteuil nube en dolxe 3005

Butaca Nube página izquierda en Dolxe 3006  
 1. Nube chair in dolxe 3006 / Fauteuil Nube en dolxe 3006



## Características técnicas / Technical characteristics / Caractéristiques techniques

- ESTRUCTURA: MADERA DE PINO Y PARTÍCULAS.
- RECUBRIMIENTO: ESPUMA DE POLIURETANO DE 1,5 CM.
- ALMOHADAS ASIENTOS: GOMA 35 KG
- ALMOHADAS RESPALDO: GOMA 30 KG
- PATAS: METÁLICAS

- STRUCTURE : PINE WOOD AND WOOD PARTICLES.
- RECOVERY: LAYER OF POLYURETHANE FOAM OF 1.5 CM.
- SEAT AND BACK CUSHION : FOAM OF 30 KG.
- LEGS: METAL

- STRUCTURE BOIS DE PIN ET BOIS DE PARTICULES.
- RECOUVREMENT COUCHE DE MOUSSE POLYURÉTHANE DE 1.5 CM.
- COUSSIN D'ASSIDE ET DOSSIER: MOUSSE 30 KG
- PIÈTEMET: METALLIQUE

## Tipos de patas

### GRUPO 0

SIN INCREMENTO SI NO VAN POR DEFECTO Y ES POSIBLE CAMBIAR POR PATA TIPO G0 O G1

*This type of legs can be used on certain models without cost. Ask information first / Ce genre de piétement peut être utilisé sur certain modèles sans supplément, cependant il faut s'informer d'abord parce que ce n'est pas toujours possible*



**27**

H-8

**28**

H-14

H-12

**29**

H-10

**30**

H-14

H-12

H-10

**33**

H-7,5

### GRUPO 1

SI NO LA LLEVA POR DEFECTO Y SÍ ES POSIBLE EL CAMBIO (INCREMENTO + 15 € POR PATA CON RESPECTO A G0)

*This type of leg, when used as a replacement of leg belonging to G/0, cost 15 euros each / Ce genre de pieds en remplacement de pieds du G/0 entraîne un supplément de 15 euros par pied*

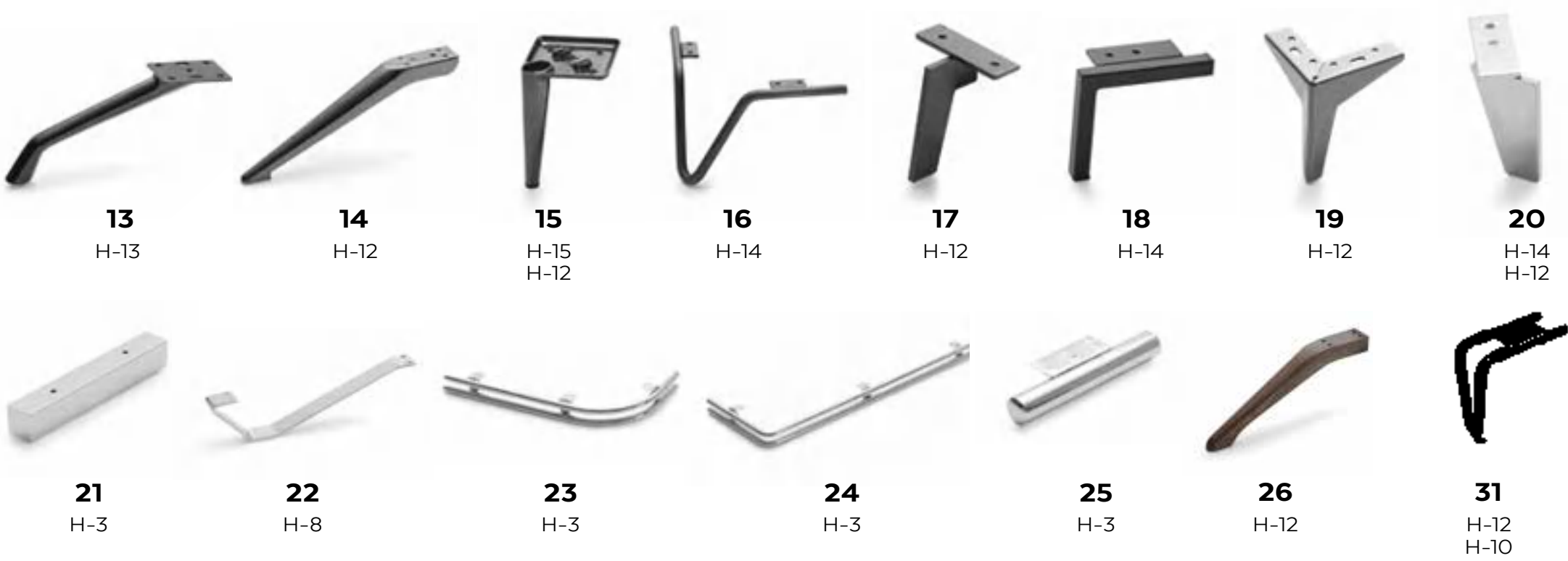

**13**

H-13

**14**

H-12

**15**

H-15

H-12

**16**

H-14

**17**

H-12

**18**

H-14

**19**

H-12

**20**

H-14

H-12

**21**

H-3

**22**

H-8

**23**

H-3

**24**

H-3

**25**

H-3

**26**

H-12

**31**

H-12

H-10

### GRUPO 2

SI NO LA LLEVA POR DEFECTO Y ES POSIBLE CAMBIAR. INCREMENTO DE 15 € POR PATA CON RESPECTO A PATAS G1. INCREMENTO DE 30 € POR PATA CON RESPECTO A PATAS G0

*If this type of leg is not the default one and is possible to use, there is an extra of 15 euros if the default one is G/1 and of 30 euros if it is G/0.*

*Si ce genre de piétement n'est pas celui par défaut et est possible d'utiliser, il y'aura un supplément de 15 euros en remplacement de pieds en G/1 et de 30 euros pour celui de G/0*

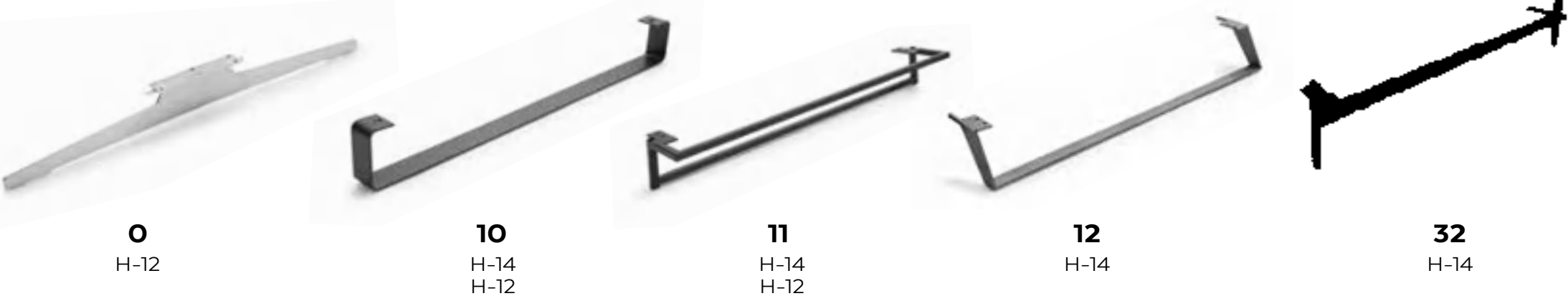

**0**

H-12

**10**

H-14

H-12

**11**

H-14

H-12

**12**

H-14

**32**

H-14

## Decorativos



**COJÍN FLOTANTE** - 25 x 15



**REBECA** - 45 x 45



**Pradas** - 55 x 55



**PLATABANDA** - 50 x 50



**HILTON** - 45 x 45



**COJÍN** - 55 x 55



**COJÍN** - 50 x 50



**RIÑONERA** - 50 x 30

### DECORATIVOS

	G-0	G-1	G-2	G-3	G-4	T.CUENTE	PIEL 1	PIEL 2	PIEL 3	PIEL 4
◇ DECO Pradas 55*55	20,5	24,5	27,5	29,5	31	18	69	83	91	100
◇ DECO 55*55	19	22	24	25	27	16	54	67	74	81
◇ DECO PLATABANDA 50*50	19	22	24	25	27	16	54	67	74	81
◇ DECO 50*50	17	19	21	22	23	15	51	65	72	79
◇ DECO REBECA 45*45	15	17	19	20	21	14	48	62	68	75
◇ DCO HILTON 45*45	15	17	19	20	21	14	48	62	68	75
◇ DECO RIÑONERA 50*30	13	15	17	18	19	12	42	54	59	65
◇ DECO FLOTANTE 25*15	10	12	14	15	16	9	34	43	47	52

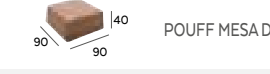
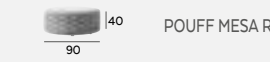
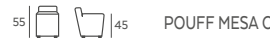

TARIFA DE PUNTOS	G-0	G-1	G-2	G-3	G-4	T/C	PIEL 1	PIEL 2	PIEL 3	PIEL 4
 140 POUFF MESA DESENFUNDABLE	125	155	165	175	186	105	250	260	286	315
 140 POUFF MESA REDONDO	120	150	165	175	186	105	250	260	286	315
 55 145 POUFF MESA CON RESPALDO	70	85	100	106	112	65	205	218	240	264

**CARACTERÍSTICAS POUFF MESA CON RESPALDO**









- ESTRUCTURA: MADERA DE PINO MACIZO.
- RECUBRIMIENTO: ESPUMA DE POLIURETANO DE 1,5 CM.
- PATAS: PVC PLÁSTICO.

**ABOUT THE POUF TABLE**

- STRUCTURE: PINE WOOD.
- COVERING: POLYURETHANE FOAM OF 1,5 CM.
- LEGS: PVC PLASTIC.

**SUR LE TABLE POUF**

- STRUCTURE: BOIS EN PIN.
- RECOUVREMENT: MOUSSE DE POLYURÉTHANDE DE 1,5 CM.
- PIEDS: PLASTIQUE.

Pouff	G-0	G-1	G-2	G-3	G-4	TCLIENTE	PIEL 1	PIEL 2	PIEL 3	PIEL 4
 POUFF 40X40 COJÍN FIJO	57	64	81	86	91	54	161	175	193	212
 POUFF 50X50 COJÍN FIJO	58	65	82	87	92	55	165	179	197	217
 POUFF 60X70	85	99	115	122	129	81	198	211	232	255
 POUFF VISCO. Y CAPITONÉ 82X82	190	210	230	244	259	181	250	262	288	317
 POUFF VISCO. Y CAPITONÉ 72X72	180	200	220	233	247	171	240	252	277	305
 POUFF VISCO. Y CAPITONÉ 68X68	170	190	210	223	236	162	230	241	265	292
 POUFF VISCO. 82X82	180	200	220	233	247	171	240	252	277	305
 POUFF VISCO. 72X72	170	190	210	223	236	162	230	241	265	292
 POUFF VISCO. 68X68	160	180	200	212	225	152	220	231	254	279

**Metrojes / Measurement of the fabric / Mesures du tissu**

	G-0	G-1	G-2	G-3	G-4	PIEL 1	PIEL 2	PIEL 3	PIEL 4
	7,5	11	15	17	19	24	31	35	39

NOTA: Los metrojes de tela están basados en un ancho de 1,40 metros. Los metrojes de piel están basados en m2 y deben servirse en pieles completos.

The measurement of the fabric is based upon the width of 1.40 m. Those of leather are based upon 2 m and have to be delivered in complete leather.

Les mesures du tissu sont basées sur la largeur de 1,40 mètre. Celles du cuir sont basées sur 2 mètres et doivent se livrer en cuir parfait.

**Notas importantes / Important to note / Notes importantes**

- \* DESLIZANTES MOTORIZADO 2 ASIENTOS: +100 Puntos
- \* DESLIZANTE MOTORIZADO 1 ASIENTO: +80 Puntos
- \* ARCÓN ABATIBLE: 70 puntos
- \* RINCÓN MUSICAL NO LLEVA CABEZALES
- \* TUMBONA: BRAZO HASTA EL FINAL
- \* CHAISLONGUE: BRAZO EN MARTILLO
- \* MV1: BRAZO MÓVIL EN LA CHAISLONGUE
- \* LAS CHAISLONGUE MV1 SOLO LLEVAN 1 DECORATIVO, Y EN PIEL NO LLEVAN DECORATIVO.
- \* Reducción medidas de brazo 30 puntos por brazo
- \* Nuestros cojines de asiento son de poliuretano 30 kg. fibra siliconada y viscoelástica, los cuales dan una sentada blanda y confortable. NO será motivo de cambio esa cualidad. Si se quisieran cambiar los cojines de asiento se facturará 105 puntos hasta la devolución del cambio.

- \* 2 sliding and motorized seats: 100 points
- \* 1 sliding and motorized seat: 80 points
- \* folding safe: 70 points
- \* deck chair: arm till the end( full arm)
- \* Long chair: arm in hammer shape
- \* MV1: movable arm in the long chair
- \* Long chairs MV1 in fabric include one decorative meanwhile those in leather don't include that decorative.
- \* Arm reduction: 30 points per arm
- \* Our seat cushions are made of polyurethane 30 kg, siliconed fibre and "viscoelastic", which provide a comfortable and smooth sitting.This quality will never be a reason of change.If ever one would like to change the seat cushion,we will have to charge for that,105 points until the complete reception of the changed material.

- \* Couissant motorisé avec deux assises: +100 points
- \* Couissant motorisé avec une assise: +80 points
- \* Chaise pliante: +70 points
- \* Transat: bras jusqu'à la finition.
- Chaise longue: Bras en forme de marteau.
- Les chaises longues MV1 sont accompagnées uniquement d'un décoratif Celles qui sont en cuir ne sont pas accompagnées de décoratifs.
- \* Réduction de bras: On appliquera 30 points pas bras.
- \* Nos coussins d'assise sont en polyuréthane de 30 kg, fibre siliconné y viscoélastique, lesquels procurent une assise confortable et agréable.La qualité ne sera sans doute pas cause de changement.Au cas où on voudrait changer les coussins d'assise, la facture augmentera de 105 points jusqu'à la restitution totale du matériel.

**Condiciones de venta / Trade conditions / Conditions de vente**

- I.V.A.: El que corresponda irá cargado en factura.
- IMPAGADOS: El curso de un pedido quedará paralizado si hubiese anomalías de cobros pendientes. En caso de impago, las partes se someten a los Juzgados y Tribunales de Almansa con renuncia expresa de sus fueros propios.
- En caso de rotura o desperfecto de la mercancía: La empresa se responsabiliza de la recogida de la misma en el menor tiempo posible, siempre y cuando lo tengan embalado,(sin exigencias de cambio).
- PORTES: Pagados (excepto metrojes y cojines decorativos sueltos). Los metrojes que se tengan que enviar por agencia o a otro fabricante (sillas, sillones, sofás, etc.) se cobran portes (16 puntos). Los metrojes enviados para fabricar en Tela Cliente, han de ser a portes pagados.
- Los metrojes y cojines decorativos no tienen ningún tipo de descuento.
- PEDIDOS: Todos los pedidos o reclamaciones deben pasarse por fax o e-mail.
- Las posiciones de los módulos siempre son "de sentado". Es necesario indicar la medida de los módulos. Se enviará junto con el pedido un croquis para evitar errores.
- Los sofás con medidas de 2,20 en adelante se pueden fabricar con los brazos desmontados (consultar con fábrica).
- Cuando el pedido se fabrica en dos telas de diferentes series, siempre se aplicará la serie más alta.
- Las medidas especiales tendrán que consultar con fábrica si se pueden fabricar. En caso afirmativo, llevarán un incremento de un 25% sobre el sofá modificado, siendo el plazo de entrega superior a lo normal.
- ANULACIONES: "Divani Star" no se responsabiliza de los pedidos anulados a tienda por el cliente final o de los errores ajenos a esta empresa.
- "Divani Star" se reserva el derecho a cambiar características de algunos de los componentes de los modelos comercializados, por imperativos de sus proveedores o mejora de los mismos. Queda prohibida la reproducción total o parcial de cualquier imagen sin autorización de "Divani Star".
- Los precios de esta tarifa solo serán válidos para pagos a 30 días, para plazos superiores, dicha tarifa podrá sufrir un incremento.

Orders: All the orders or complaint should be sent by fax or email. The positions of the pieces are always from a sitting view. It is necessary to indicate the measurement of the pieces.To avoid mistakes, a sketch will be sent with the order. The couches the are of 2.20 metres and longer can be made with the arms removed. (consult with the factory) When the product is made with two different fabrics series, that of the highest series will be taken into account instead of the lowest. The special measurements should be consulted with the factory to determinate the possibilities. Whenever it is possible, there will be an increasing of 25% over the modified couch nowing that the delivery date will be further. Delivery paid (except duration and loose decorative cushions). The transport of the material that has to be sent via different agencies or manufacturer (chairs, armchairs, couches, etc) will cost 16 points. The transport of the material that are sent to be made in the client's fabric should be paid by the very client. There is no reduction in materials and cushions. Cancellations: "Divani Star S.L."is not responsible of the orders canceled at the shop by the client or the mistake out of the control of the factory. Reserved rights to change feature of some of the components commercialized models under obligation of the supplier to improve them. It is prohibited to reproduce partially or totally any image or item without the previous authorization of "Divani Star" The prices of this rate are valid only for a payment at 30 days. The some prices can be increased if the payment lasts longer. UNPAYMENT:The course of an order can be paralyzed if ever there is a pending payment problem.In case of an unpayment, both subdue to judges and courts in ALMANSA with express resignation of there own status. In case the merchandise is broken or suffer a certain imperfection, the company is responsible of its recollection the soonest possible, if and only if it is packed up (without change requirement).

COMMANDES: toutes les commandes ou réclamations doivent nous étres transmises par courrier électronique ou par fax.La position des modules se considère toujours en position assise..Il est nécessaire de bien préciser les dimentions des modules.Un croquis du design doit accompagner la commande pour éviter toute erreure possible. Les canapés avec des mesures de 2,20 mètres ou plus peuvent se faire avec les bras démontés( pour cela il faut en parler avec la compagnie fabricante).Lorsque la commande se fait en deux tissus différents ,on tiendra en compte celui de la plus haute gamme. Les modèles spéciaux doivent être auparavant consultés avec la compagnie pour voir les différentes possibilités. Au cas affirmatif,il y 'aura une augmentation de 25% sur le prix du fauteuil modifié,et bien entendu,le délai de réception sera plus ample. TRANSPORT: Le transport est payé ( à l'exception de métrages et coussins décoratifs séparés.)le matériel qui fera objet d'envoi par agence de transport ou un autre fabriquant (chaises,fauteuil,canapés,etc) connaîtra une augmentation de 16 points . Le transport du matériel qui s'envoie par le client pour son choix personnel sera payé par ce dernier.Le matériel et les coussins ne souffrent aucune réduction. ANNULATIONS: "DIVANI STAR S.L."n'est pas responsable des commandes annulées par le client chez le distributeur ou les erreurs qui en proviennent pas de l'entreprise. "Divani Star S.L." se reserve le droit de changer les caractéristiques de quelques modèles commercialisés,par obligation des fournisseurs ou pour l'amélioration en qualité du produit. Il est formellement interdit de reproduire partiellement ou totalement n'importe quel image ou article appartenant a DIVANI STAR sans autorisation préalable de ce dernier. Les prix de ce tarif seront valables seulement et seulement si la poiement s'effectue au courant des 30 premiers jours a compter du jour de livraison.Pour ceux qui payent plus tard,le tarif peut souffrir quelques petites augmentations. IMPAYÉS: Le cours de cette commande peut être paralísé si par hasard le client accumule des factures impayées. Au cas où les factures ne sont pas payées comme prévu,les deux parties peuvent se confronter au tribunal de ALMANSA devant les juges afin de trouver un terrain d'entente et se départager à l'amiable. Au cas où le produit se rompt ou souffre une imperfection, la compagnie se porte garante pour sa récupération dans le plus brief délai toute fois que le produit soit introduit dans son emballage ( sans exigence de changement).

\*DIVANI DOESN'T ACCEPT THE RETURN OF SOFAS MADE IN SPECIAL DIMENSIONS\*

THE COLUMN OF FABRIC BY METER REFERS TO THE NECESSARY QUANTOTY OF FABRIC FOR THE MANUFACTURING OF THE CORRESPONDING ITEM IN PROVIDE FABRIC FOR SOFAS IN PROVIDED LEATHER , THE CLIENT HAS FIRST TO ASK FOR QUOTATION AND QUANTITY OF LEATHER

\*LES COMMANDES EN DIMENSIONS SPECILES NE PEUVENT EN AUCUNE CIRCONTANCE ETRE RETOURNÉS A L'USINE\*

LA COLONNE DU TISSU AU METRE SUR LES TARIFS FAIT REFERENCE A LA QUANTITE DE TISSU NECESSAIRE POUR LA FABRICATION DE L'ELEMENT CORESPONDANT EN TISSU FOURNI. POUR LES COMMANDES EN CUIR FOURNI , LE CLIENT DOIT D'ABORD DEMANDER QU'ON LUI FASSE UN DÉVIS ET L'INFORMER DE LA QUANTITÉ DE CUIR NECESSAIRE .



**OVN**<sup>®</sup>  
S T A R  
La marca que mejor te sienta

**OVNI**<sup>®</sup>  
**S T A R**

La marca que mejor te sienta

Pol. Ind. Los Molares. - Calle Molares, 4  
02650 Montealegre del Castillo ALBACETE (SPAIN)  
T: +34 967 336 221 - F: +34 967 33 55 88  
info@divanistar.com

[www.divanistar.com](http://www.divanistar.com)